

SEC.NO.	A	B	T	WT.Kg/mtr.
3602	51.00	10.00	1.00	0.237
3604	56.00	10.50	1.30	0.282

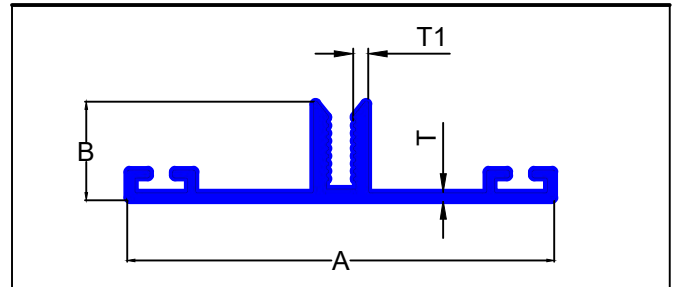

SEC.NO.	A	B	T	T1	WT.Kg/mtr.
3607	56.50	13.00	1.20	1.60	0.325

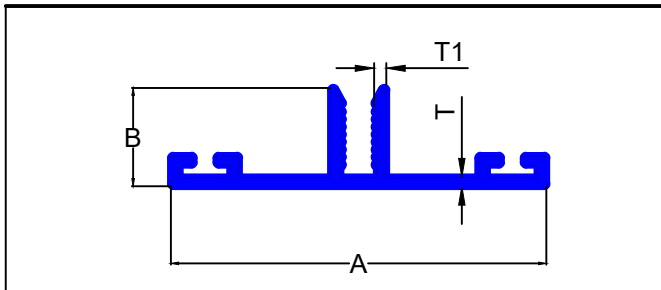

SEC.NO.	A	B	T	T1	WT.Kg/mtr.
3608	49.70	12.60	1.20	1.40	0.286
3609	49.70	13.00	1.20	1.60	0.303

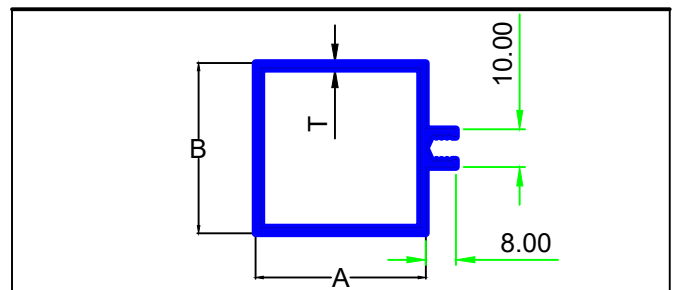

SEC.NO.	A	B	T	WT.Kg/mtr.
3615	45.00	45.00	0.95	0.545
3616	45.00	45.00	1.50	0.791
3617	45.00	45.00	1.70	0.888

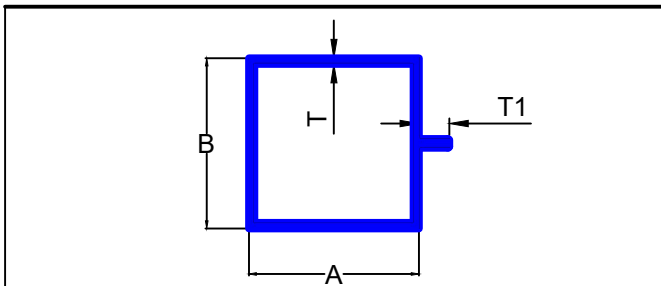

SEC.NO.	A	B	T	T1	WT.Kg/mtr.
3619	45.00	45.00	1.50	8.00	0.749
3620	45.00	45.00	1.80	8.00	0.883

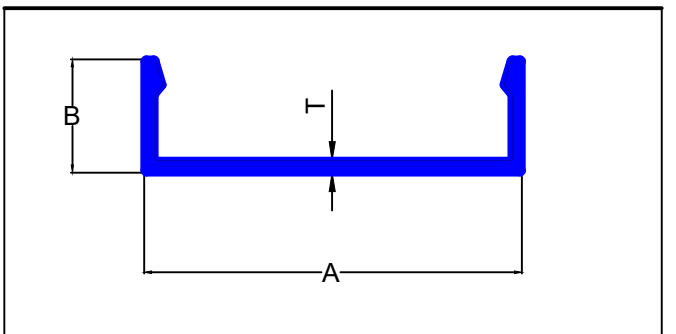

SEC.NO.	A	B	T	WT.Kg/mtr.
3621	50.00	15.00	1.60	0.331

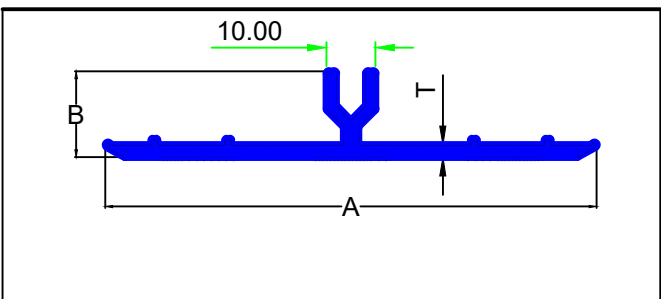

SEC.NO.	A	B	T	WT.Kg/mtr.
3623	100.00	17.50	2.50	0.822

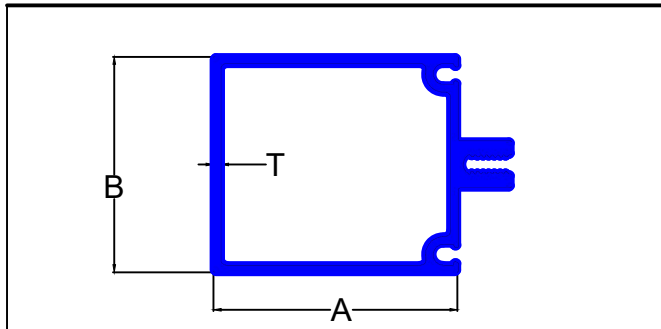

SEC.NO.	A	B	T	WT.Kg/mtr.
3625	63.00	57.00	1.70	1.476
3632	101.60	57.00	3.15	2.431
3640	135.00	57.00	3.15	2.826

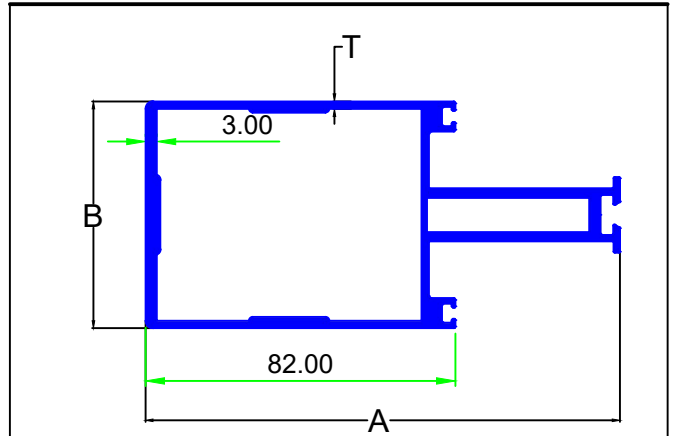

SEC.NO.	A	B	T	WT.Kg/mtr.
3633	125.50	60.00	2.00	2.690

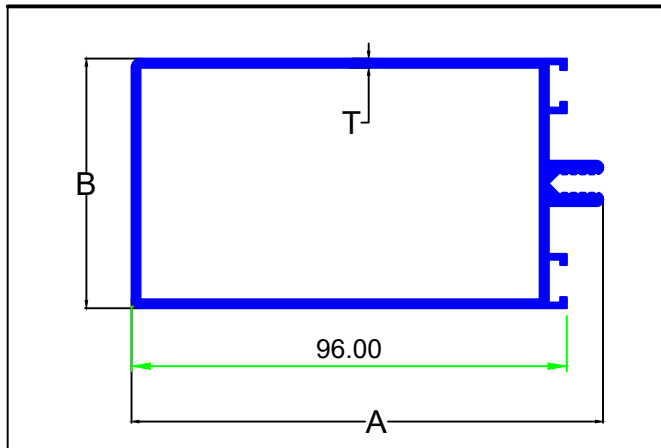

SEC.NO.	A	B	T	WT.Kg/mtr.
3634	104.00	55.00	2.00	1.749

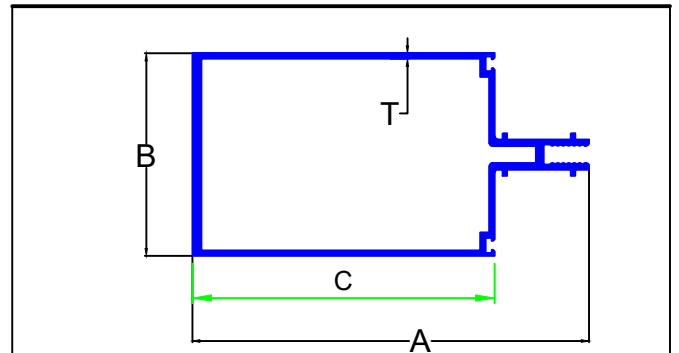

SEC.NO.	A	B	C	T	WT.Kg/mtr.
5706	167.02	67.00	135.86	2.40	3.218

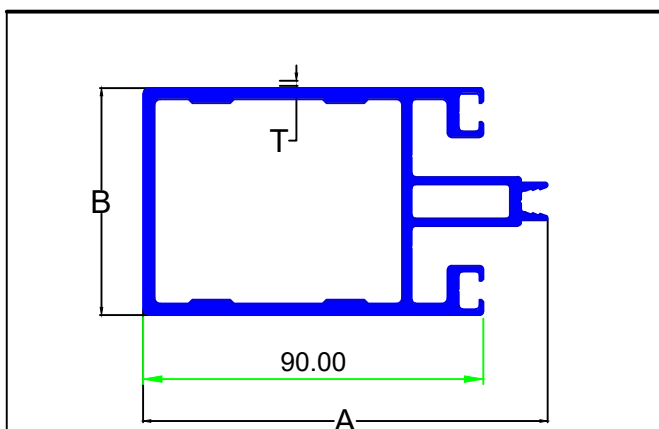

SEC.NO.	A	B	T	WT.Kg/mtr.
3636	107.00	60.00	3.00	3.025

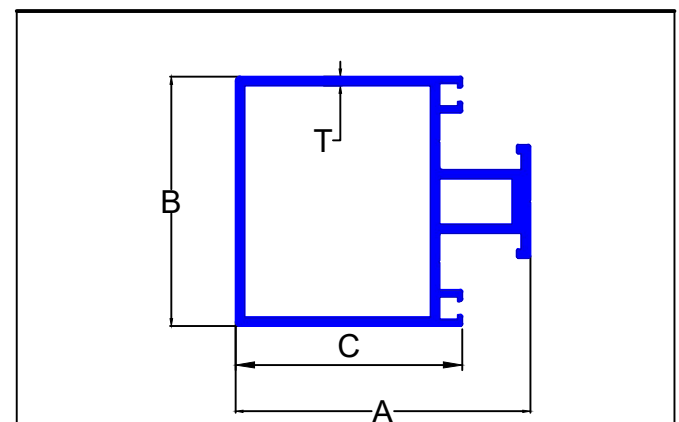

SEC.NO.	A	B	C	T	WT.Kg/mtr.
3637	65.00	55.00	50.00	2.00	1.519
3654	164.66	75.00	130.00	2.00	2.833
3693	146.00	60.00	110.00	1.80	2.304

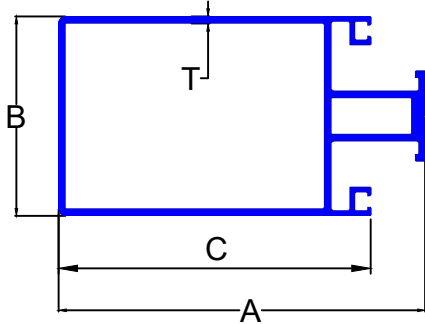

SEC.NO.	A	B	C	T	WT.Kg/mtr.
3638	101.00	55.00	86.00	2.00	2.010
3639	150.00	55.00	135.00	2.00	2.535
3647	175.00	60.00	160.00	2.50	3.665
3648	185.00	55.00	170.00	2.00	2.913
3650	116.00	55.00	101.00	2.00	2.168
3655	154.81	80.00	120.00	2.00	3.257

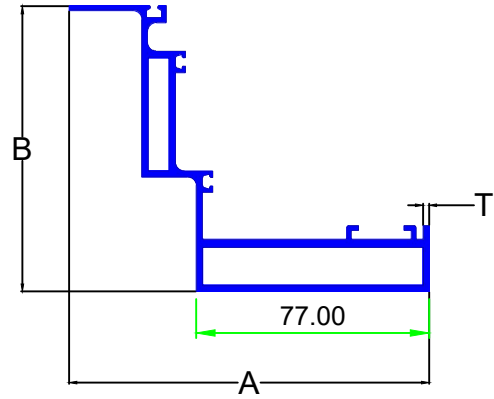

SEC.NO.	A	B	T	WT.Kg/mtr.
3643	119.00	94.30	2.00	2.133

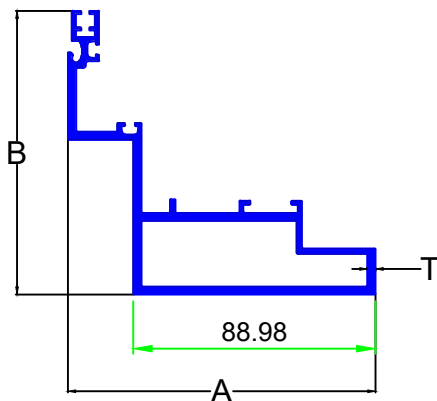

SEC.NO.	A	B	T	WT.Kg/mtr.
3644	112.97	104.23	3.00	2.720

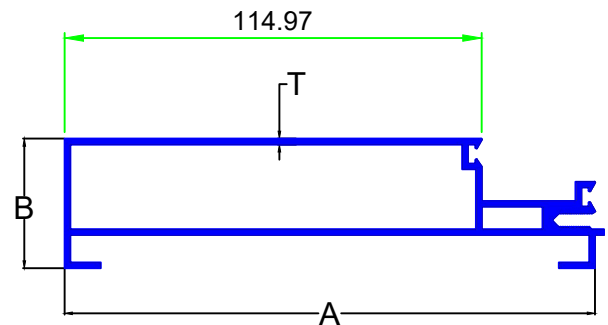

SEC.NO.	A	B	T	WT.Kg/mtr.
3645	148.66	35.69	1.60	1.796

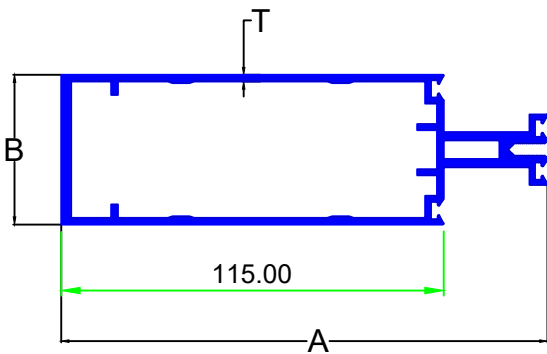

SEC.NO.	A	B	T	WT.Kg/mtr.
3646	146.20	45.00	2.00	2.538

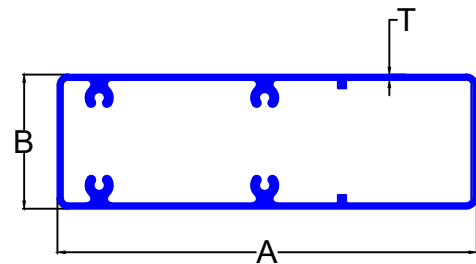

SEC.NO.	A	B	T	WT.Kg/mtr.
3649	154.00	49.20	2.00	2.865

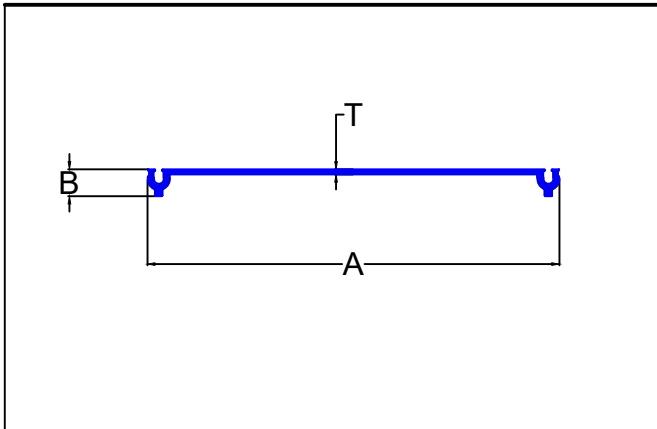

SEC.NO.	A	B	T	WT.Kg/mtr.
3652	194.28	12.82	2.50	1.563

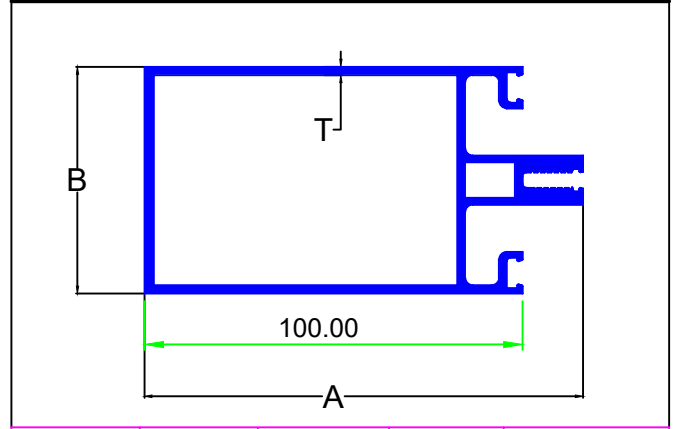

SEC.NO.	A	B	T	WT.Kg/mtr.
3657	116.00	60.00	2.20	2.566

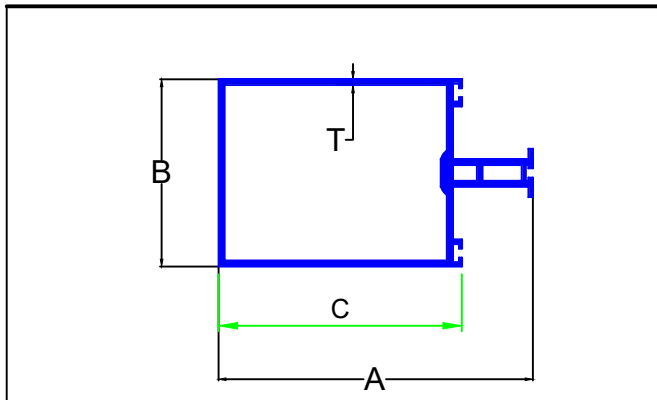

SEC.NO.	A	B	C	T	WT.Kg/mtr.
3658	104.00	62.00	80.50	2.00	1.962
3659	125.00	62.00	101.50	2.50	2.607

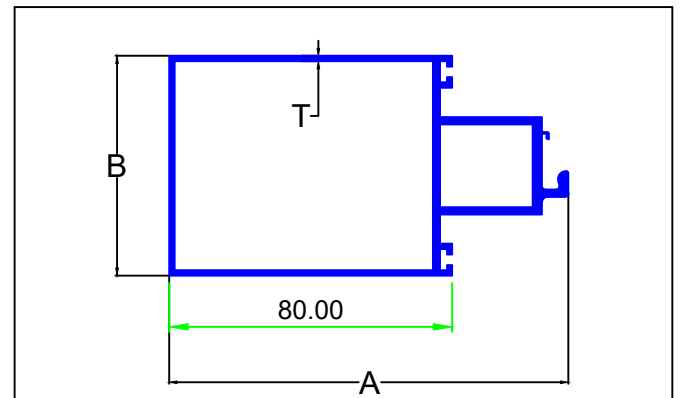

SEC.NO.	A	B	T	WT.Kg/mtr.
3660	112.78	62.10	1.50	1.814

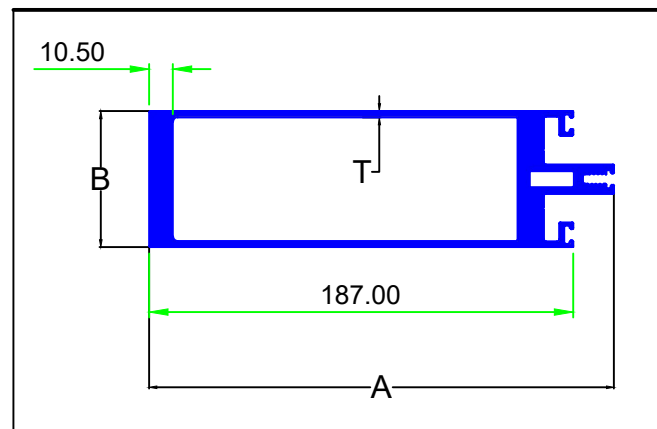

SEC.NO.	A	B	T	WT.Kg/mtr.
3661	205.00	60.00	2.75	6.670

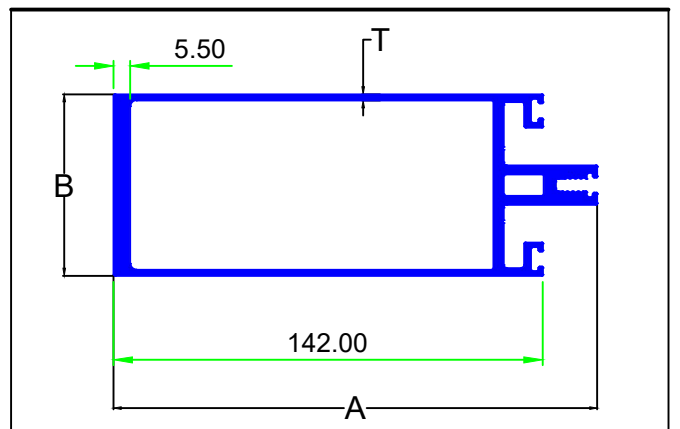

SEC.NO.	A	B	T	WT.Kg/mtr.
3662	160.00	60.00	2.00	3.697

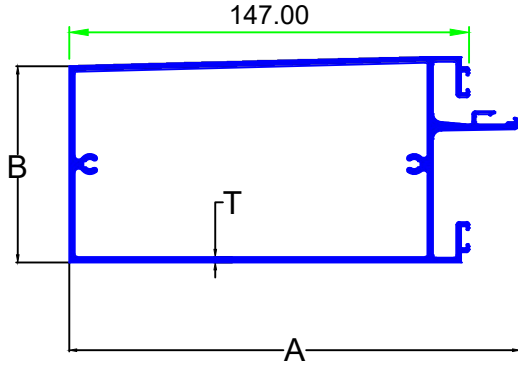

SEC.NO.	A	B	T	WT.Kg/mtr.
3663	165.78	72.00	2.00	2.901

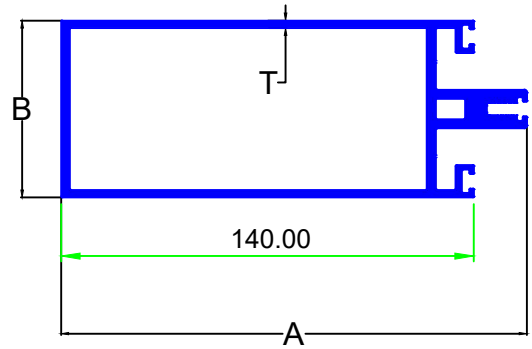

SEC.NO.	A	B	T	WT.Kg/mtr.
3664	158.00	60.00	2.50	3.623

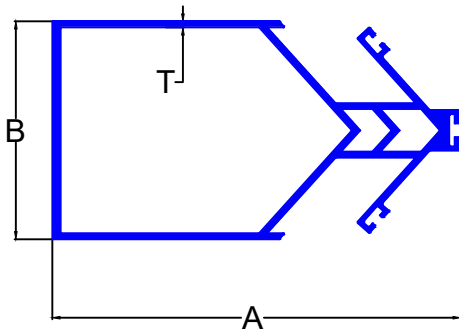

SEC.NO.	A	B	T	WT.Kg/mtr.
3665	149.95	80.00	2.20	3.537

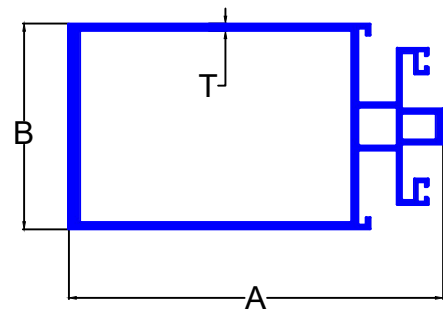

SEC.NO.	A	B	T	WT.Kg/mtr.
3666	155.00	85.00	3.00	4.851

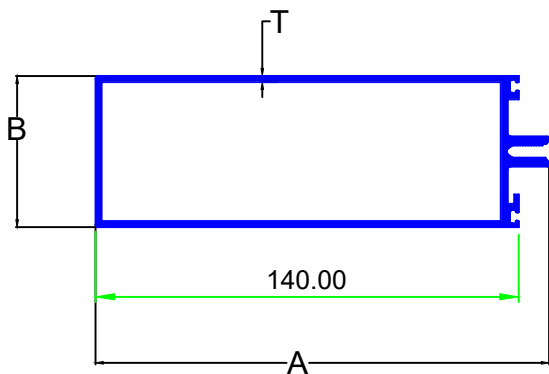

SEC.NO.	A	B	T	WT.Kg/mtr.
3667	150.00	50.00	2.00	2.319

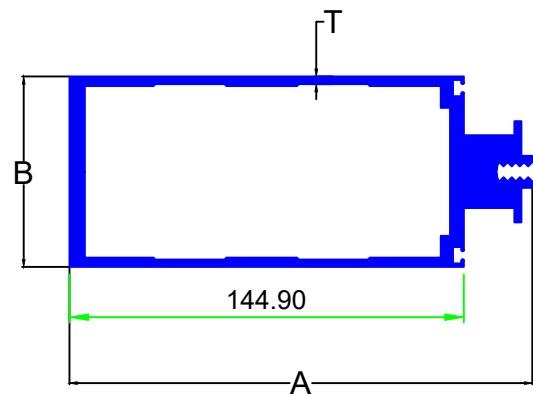

SEC.NO.	A	B	T	WT.Kg/mtr.
3668	170.00	70.00	2.80	5.171

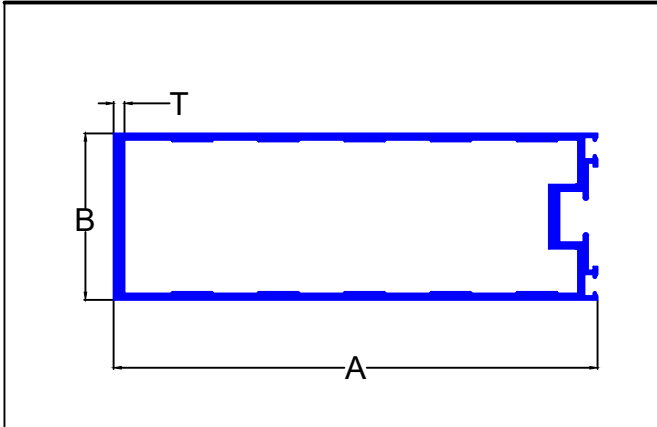

SEC.NO.	A	B	T	WT.Kg/mtr.
3669	160.00	55.00	3.62	3.089

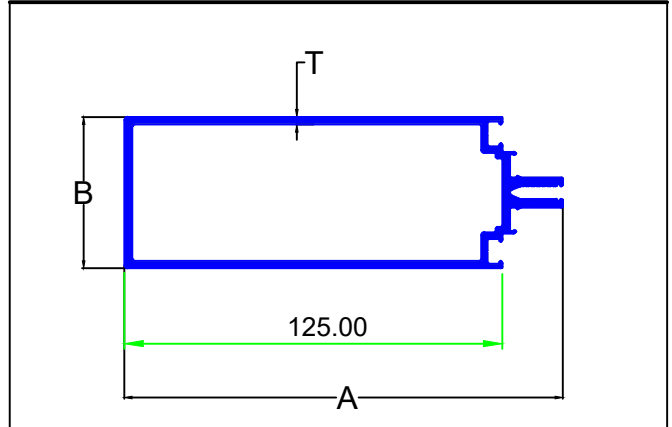

SEC.NO.	A	B	T	WT.Kg/mtr.
3670	145.00	50.00	2.50	2.636

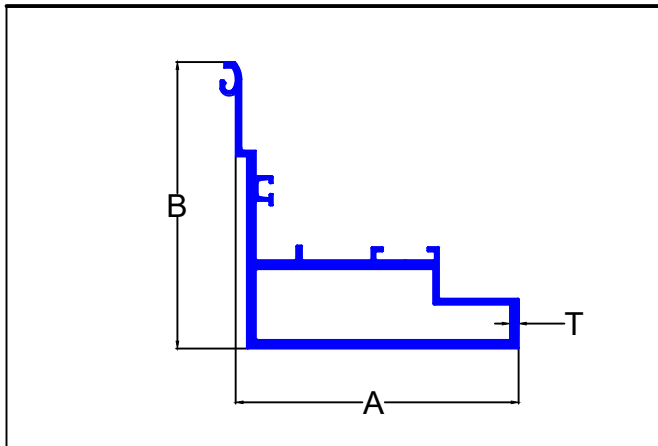

SEC.NO.	A	B	T	WT.Kg/mtr.
3671	96.08	97.22	3.00	2.457

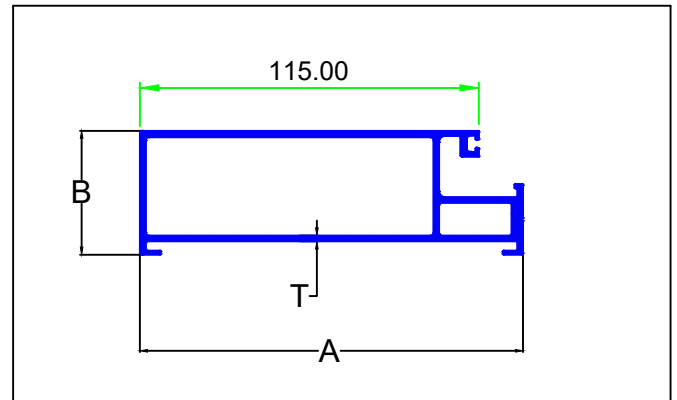

SEC.NO.	A	B	T	WT.Kg/mtr.
3672	130.00	42.00	2.00	2.206

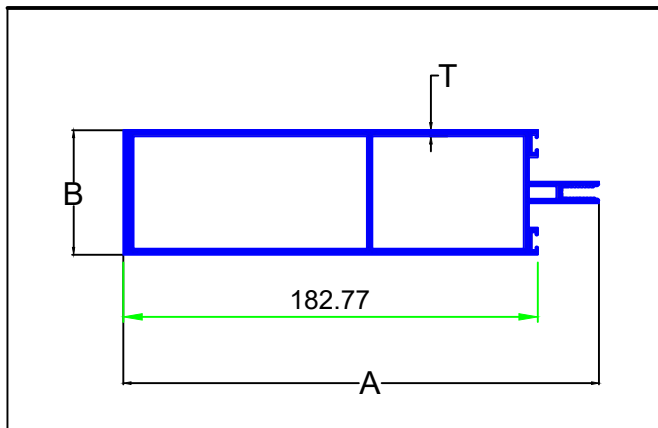

SEC.NO.	A	B	T	WT.Kg/mtr.
3673	209.75	55.00	2.75	4.418

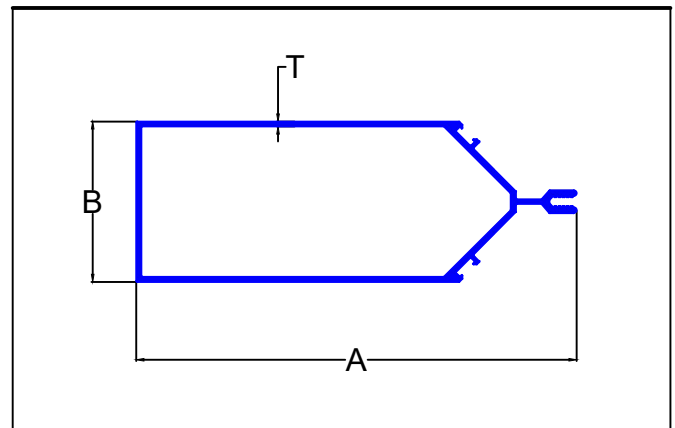

SEC.NO.	A	B	T	WT.Kg/mtr.
3674	194.19	70.71	2.20	3.001

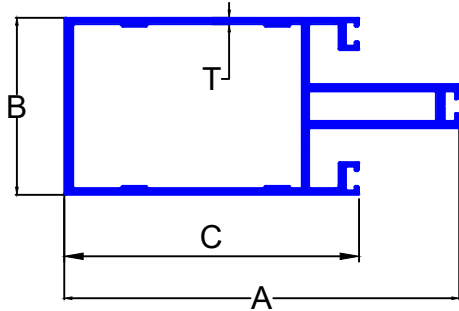

SEC.NO.	A	B	C	T	WT.Kg/mtr.
3675	134.00	60.00	100.00	2.20	3.043
3681	122.00	60.00	104.00	2.20	2.874

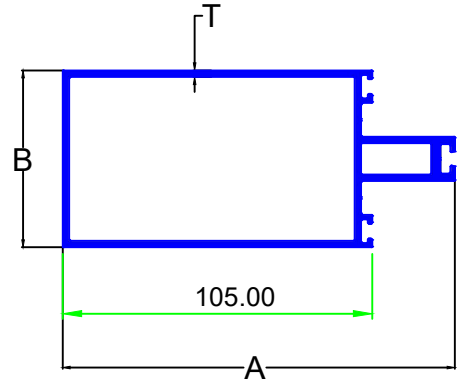

SEC.NO.	A	B	T	WT.Kg/mtr.
3676	133.00	60.00	2.20	2.441

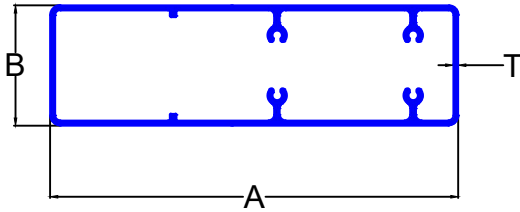

SEC.NO.	A	B	T	WT.Kg/mtr.
3677	180.00	53.00	2.20	3.338
3688	180.00	60.00	2.20	3.400

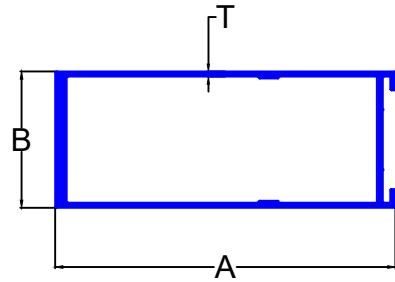

SEC.NO.	A	B	T	WT.Kg/mtr.
3678	150.00	60.00	2.20	3.017

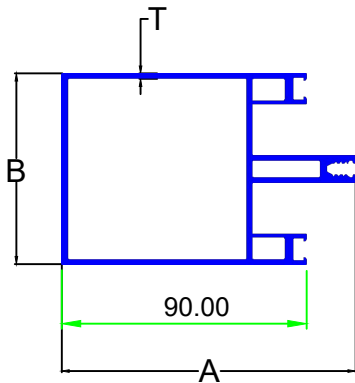

SEC.NO.	A	B	T	WT.Kg/mtr.
3679	108.00	70.00	2.00	2.539

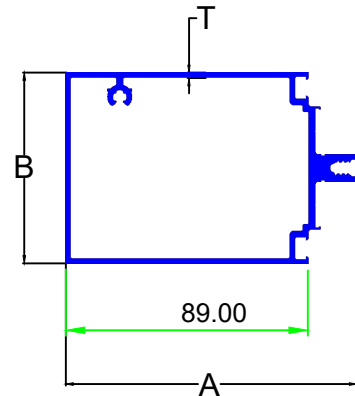

SEC.NO.	A	B	T	WT.Kg/mtr.
3680	107.00	70.00	2.00	2.239

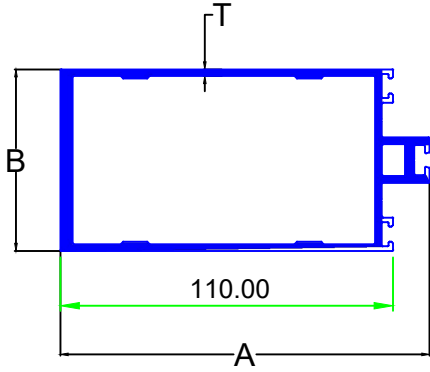

SEC.NO.	A	B	T	WT.Kg/mtr.
3682	122.00	60.00	2.20	2.656

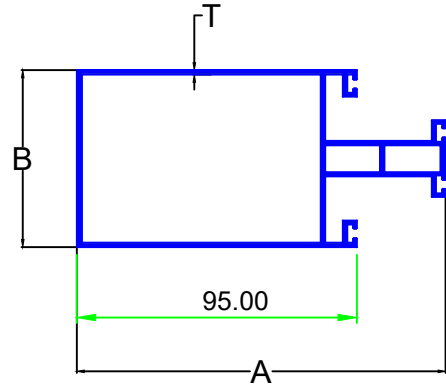

SEC.NO.	A	B	T	WT.Kg/mtr.
3683	125.13	60.00	1.50	1.869

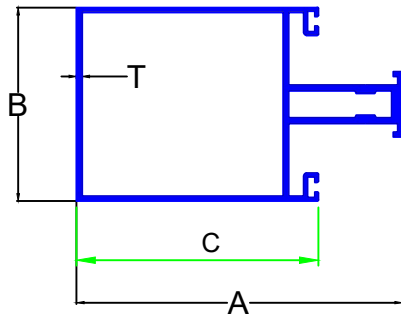

SEC.NO.	A	B	C	T	WT.Kg/mtr.
3685	160.00	65.00	120.00	3.00	3.206

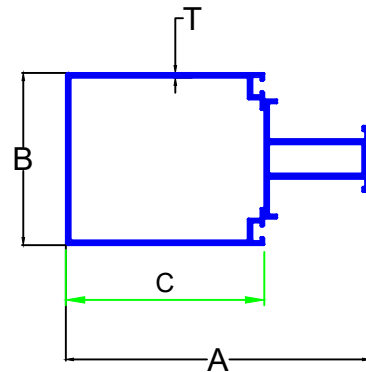

SEC.NO.	A	B	C	T	WT.Kg/mtr.
3686	115.00	65.00	75.00	1.80	1.999
3687	159.00	65.00	119.00	1.80	2.427

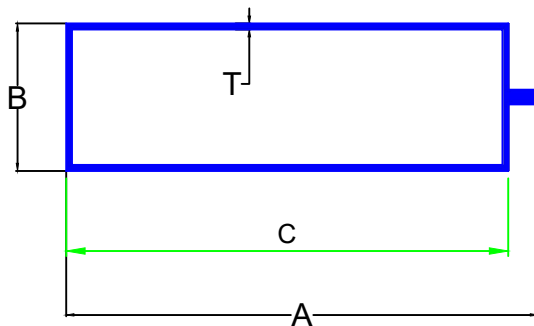

SEC.NO.	A	B	C	T	WT.Kg/mtr.
3690	137.00	65.00	129.00	2.00	2.303

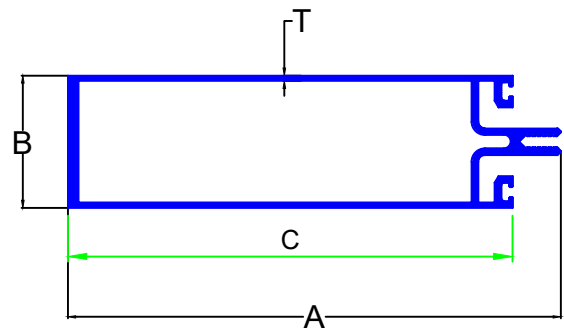

SEC.NO.	A	B	C	T	WT.Kg/mtr.
3691	186.20	50.00	168.00	2.00	3.297
3696	148.60	50.50	131.70	2.00	2.874
5701	148.60	50.50	131.70	2.00	2.811

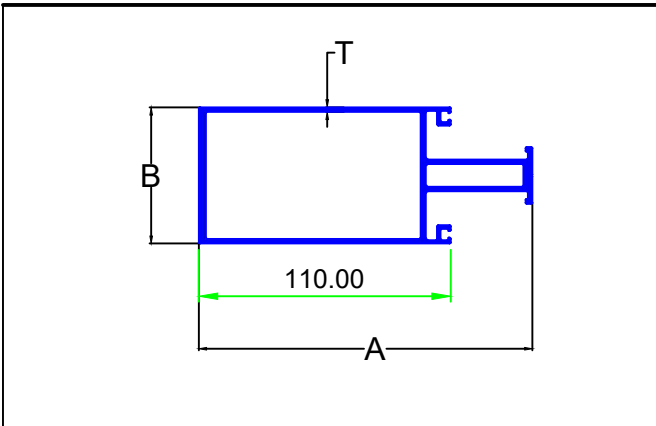

SEC.NO.	A	B	T	WT.Kg/mtr.
3692	147.00	60.00	2.00	2.750

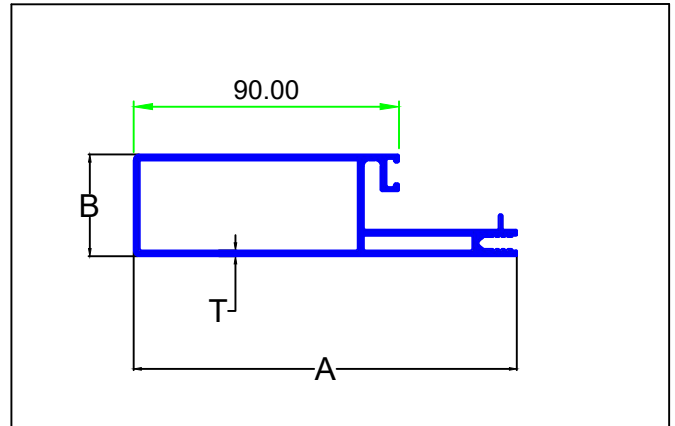

SEC.NO.	A	B	T	WT.Kg/mtr.
3694	130.00	34.50	2.00	1.956

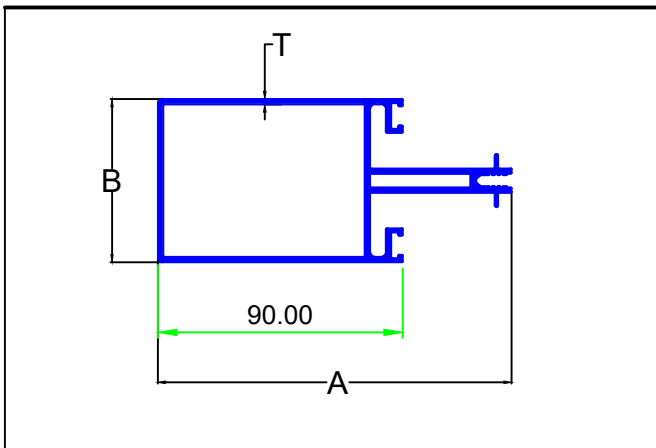

SEC.NO.	A	B	T	WT.Kg/mtr.
3695	130.00	60.00	2.00	2.397

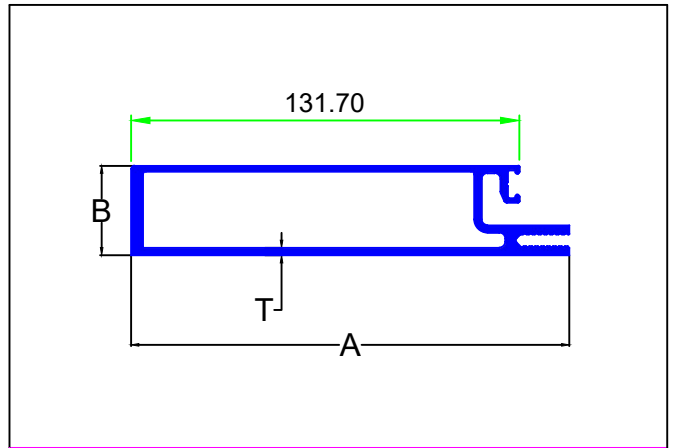

SEC.NO.	A	B	T	WT.Kg/mtr.
3697	148.60	30.30	2.00	2.516

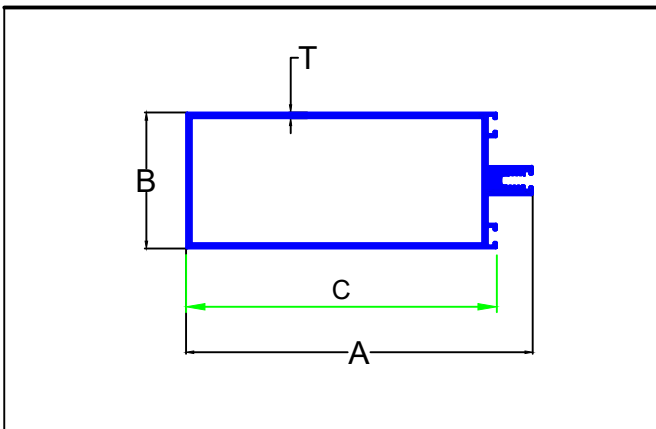

SEC.NO.	A	B	C	T	WT.Kg/mtr.
3698	152.80	60.00	137.00	2.50	3.132
5708					

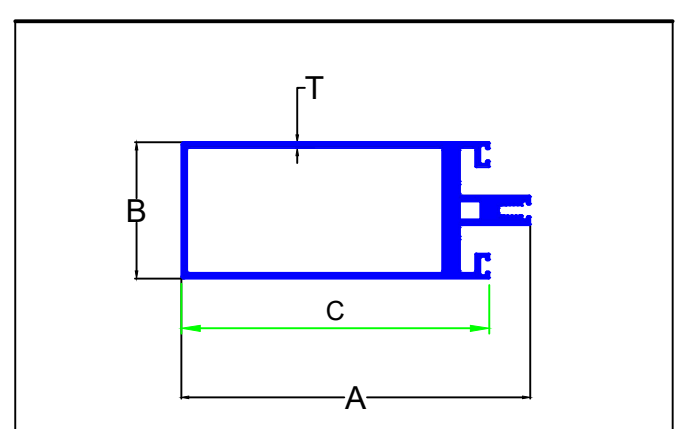

SEC.NO.	A	B	C	T	WT.Kg/mtr.
3699	153.80	60.00	135.80	2.50	4.206

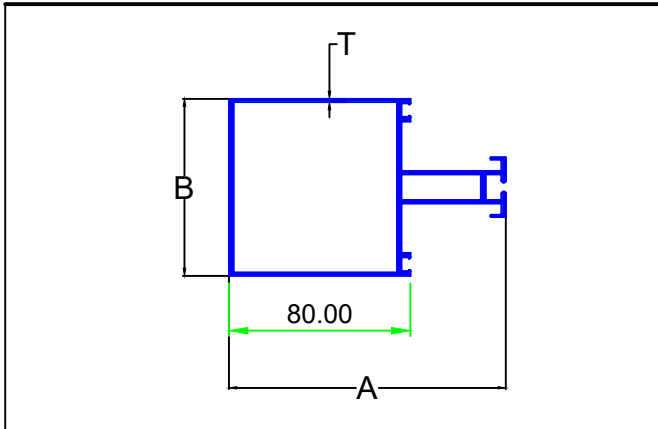

SEC.NO.	A	B	T	WT.Kg/mtr.
5700	122.00	78.00	1.50	2.077

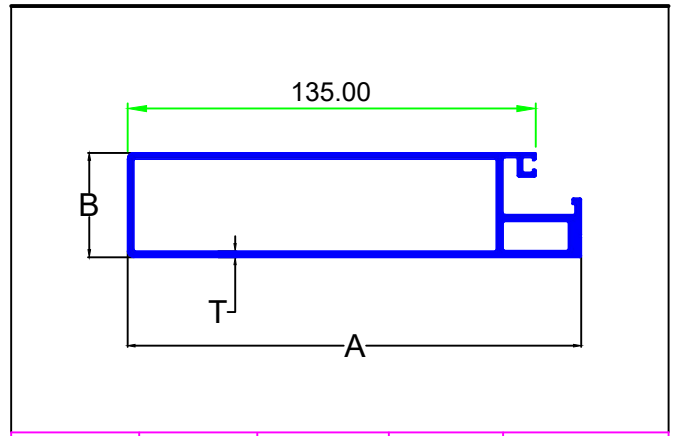

SEC.NO.	A	B	T	WT.Kg/mtr.
5702	150.00	34.50	2.00	2.183

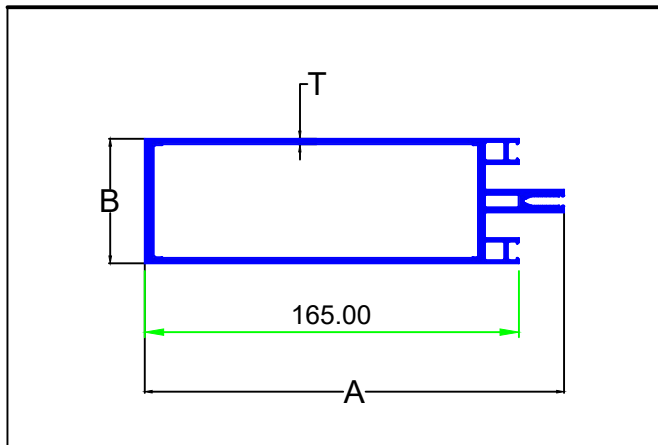

SEC.NO.	A	B	T	WT.Kg/mtr.
5703	184.98	55.00	2.50	3.836

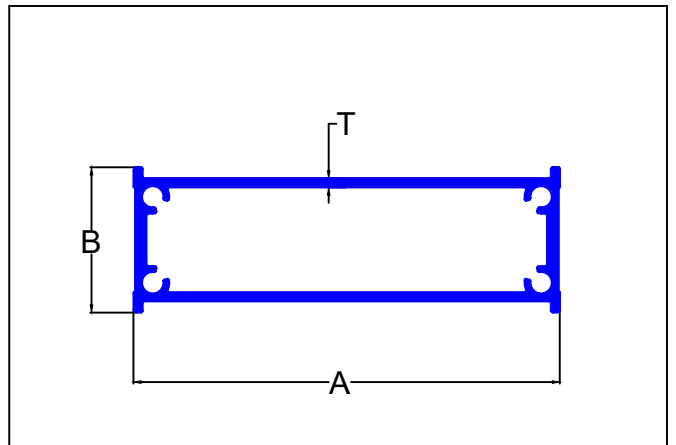

SEC.NO.	A	B	T	WT.Kg/mtr.
5704	141.00	48.00	3.00	3.210

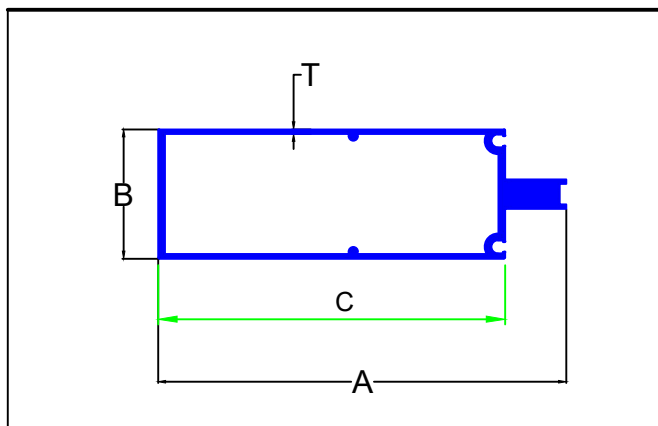

SEC.NO.	A	B	C	T	WT.Kg/mtr.
5705	180.00	57.00	153.00	2.00	3.531

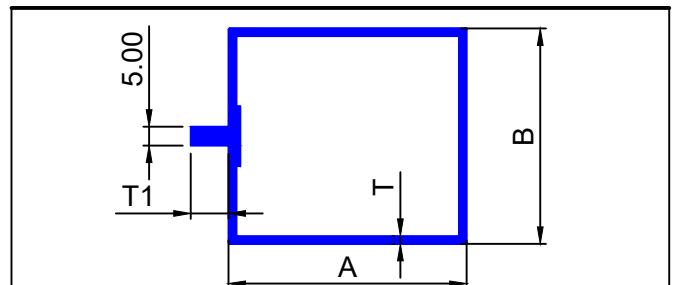

SEC.NO.	A	B	T	T1	WT.Kg/mtr.
5707	63.00	57.00	2.08	10.00	1.476

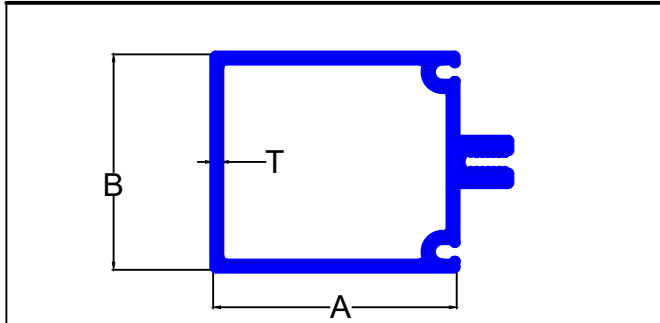

SEC.NO.	A	B	T	WT.Kg/mtr.
5709	150.70	57.00	3.00	3.780
5711	101.00	57.00	3.00	2.318
5713	64.00	57.00	2.00	1.654

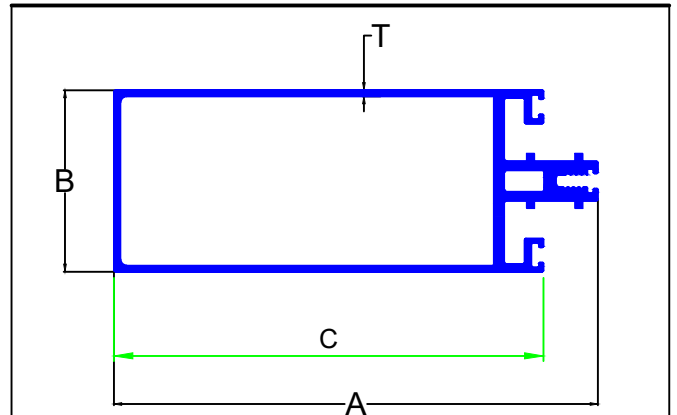

SEC.NO.	A	B	T	WT.Kg/mtr.
5710	166.00	67.00	3.00	3.600

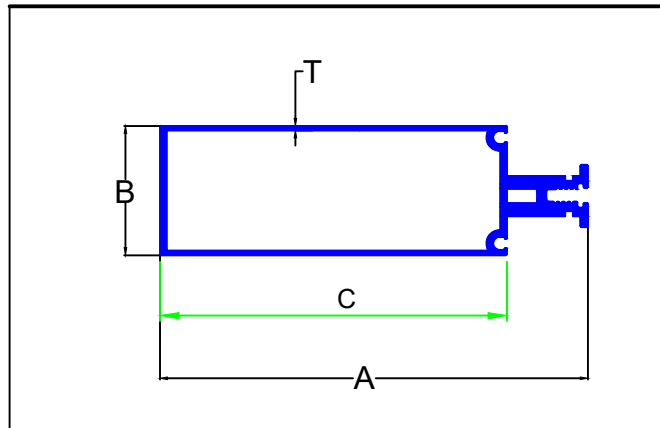

SEC.NO.	A	B	C	T	WT.Kg/mtr.
5712	150.00	70.00	110.00	2.30	3.110

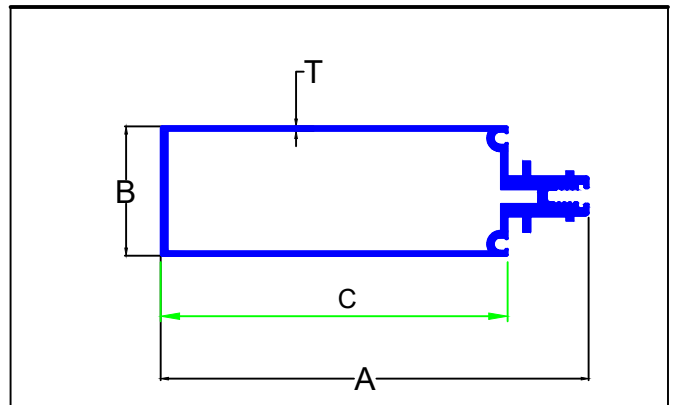

SEC.NO.	A	B	C	T	WT.Kg/mtr.
5714	132.00	67.80	99.00	2.50	2.227

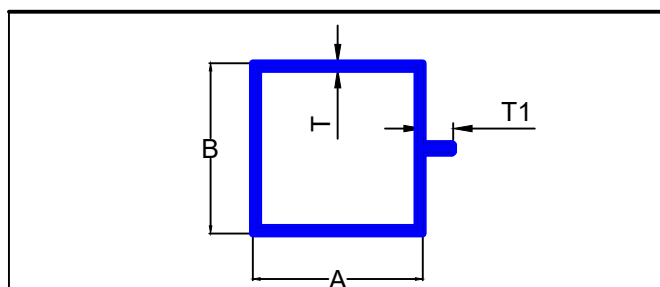

SEC.NO.	A	B	T	T1	WT.Kg/mtr.
5715	63.00	57.00	8.00	12.00	4.810

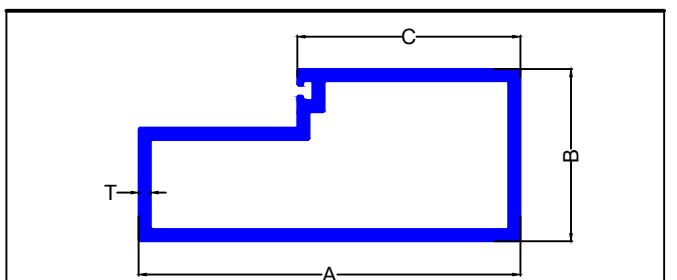

SEC.NO.	A	B	C	T	WT.Kg/mtr.
5716	101.00	45.50	59.00	3.20	2.450

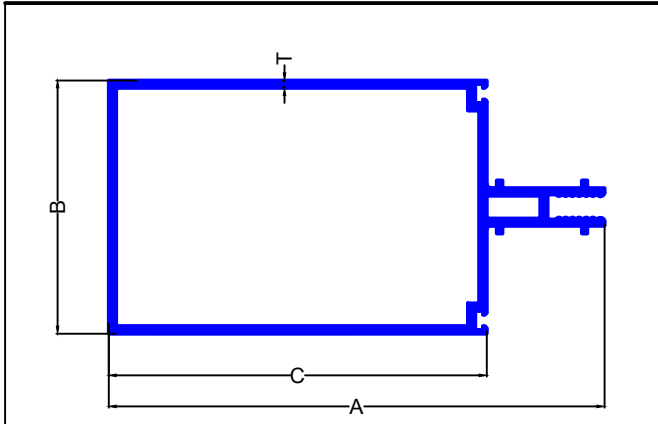

SEC.NO.	A	B	C	T	WT.Kg/mtr.
5717	131.16	67.00	100.00	2.00	2.182

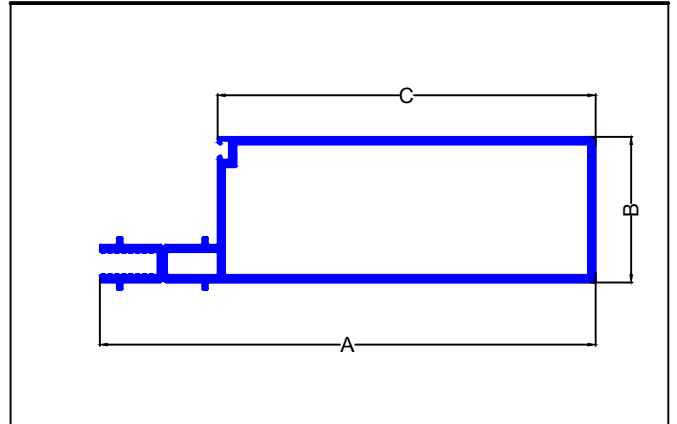

SEC.NO.	A	B	C	T	WT.Kg/mtr.
5718	131.16	38.50	100.00	2.00	1.881

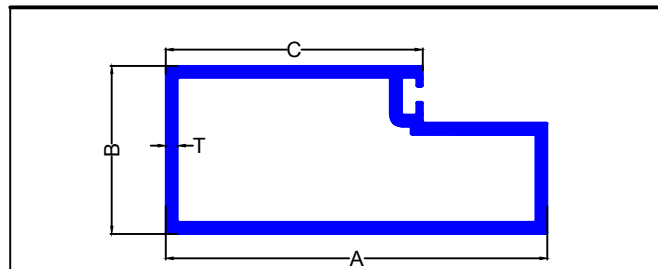

SEC.NO.	A	B	C	T	WT.Kg/mtr.
5719	101.00	44.45	68.00	3.18	2.450

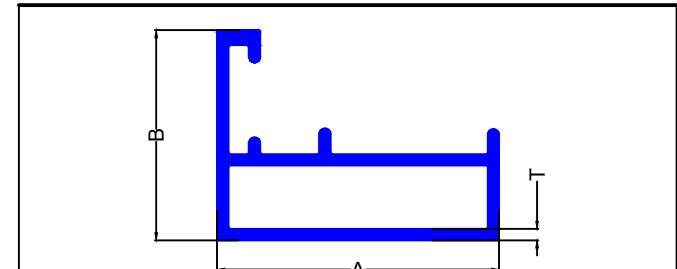

SEC.NO.	A	B	C	T	WT.Kg/mtr.
5720	37.30	27.80	-----	1.50	0.502

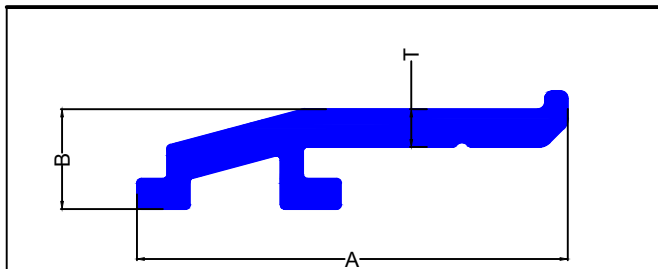

SEC.NO.	A	B	C	T	WT.Kg/mtr.
5721	28.50	6.60	-----	2.50	0.228

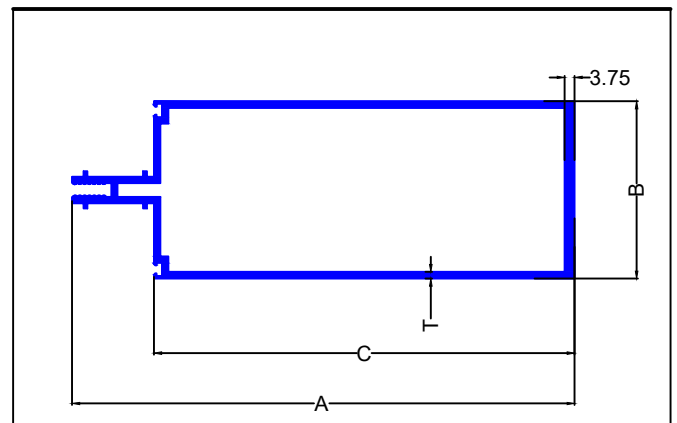

SEC.NO.	A	B	C	T	WT.Kg/mtr.
5724	190.00	67.00	159.00	2.50	3.654

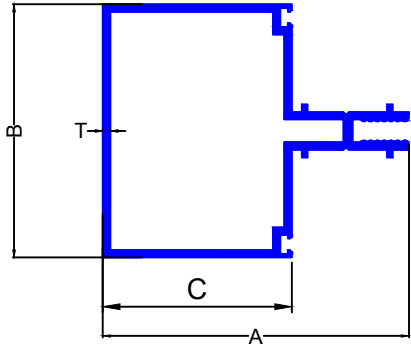

SEC.NO.	A	B	C	T	WT.Kg/mtr.
5725	81.00	67.00	50.00	2.00	1.638

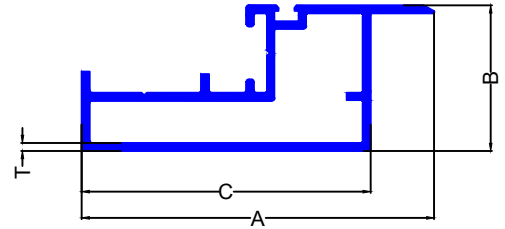

SEC.NO.	A	B	C	T	WT.Kg/mtr.
5726	66.60	27.50	54.60	1.50	0.771

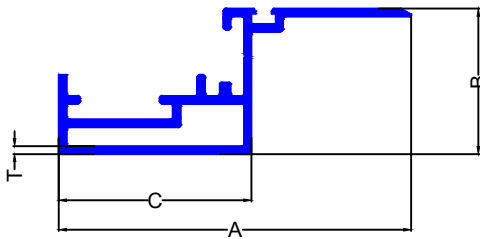

SEC.NO.	A	B	C	T	WT.Kg/mtr.
5727	66.60	27.50	36.40	1.50	0.664

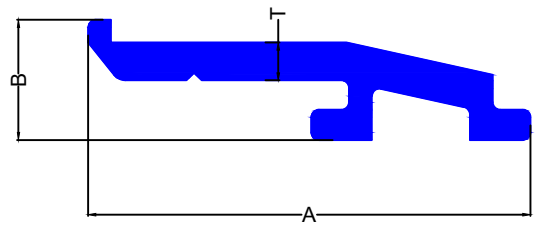

SEC.NO.	A	B	C	T	WT.Kg/mtr.
5728	29.25	7.95	-----	2.50	0.230

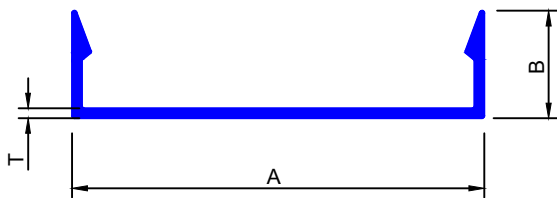

SEC.NO.	A	B	C	T	WT.Kg/mtr.
5729	54.50	14.20	-----	1.30	0.291

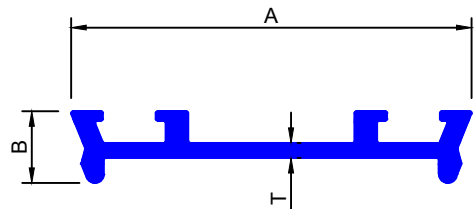

SEC.NO.	A	B	C	T	WT.Kg/mtr.
5730	53.00	9.50	-----	2.00	0.459

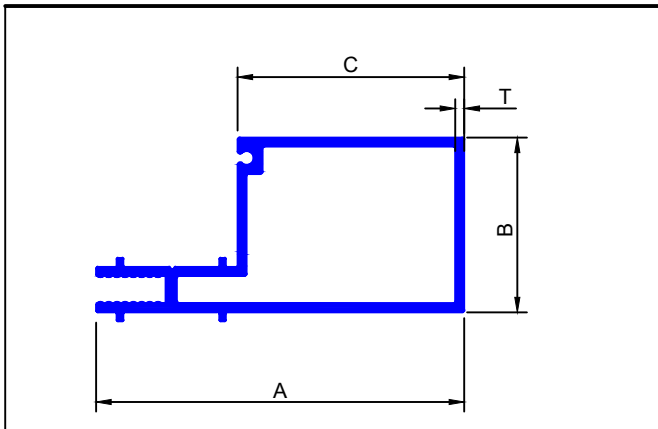

SEC.NO.	A	B	C	T	WT.Kg/mtr.
5731	81.16	38.50	50.00	2.00	1.332

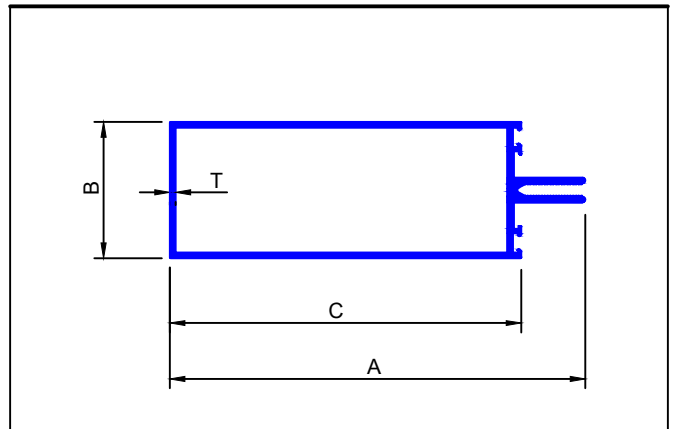

SEC.NO.	A	B	C	T	WT.Kg/mtr.
5732	183.20	60.00	155.00	2.50	3.461

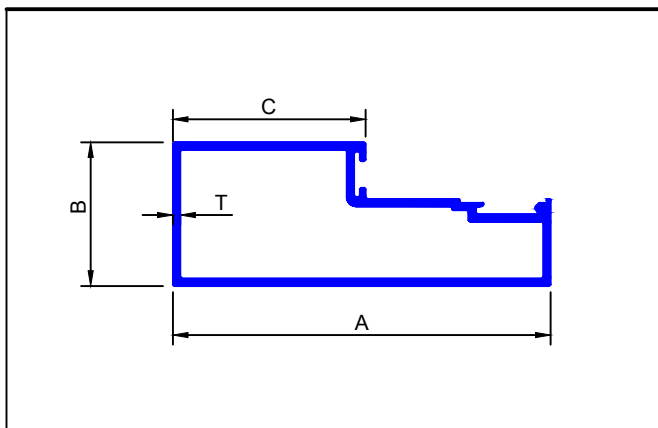

SEC.NO.	A	B	C	T	WT.Kg/mtr.
5733	100.00	38.00	51.00	2.00	1.527

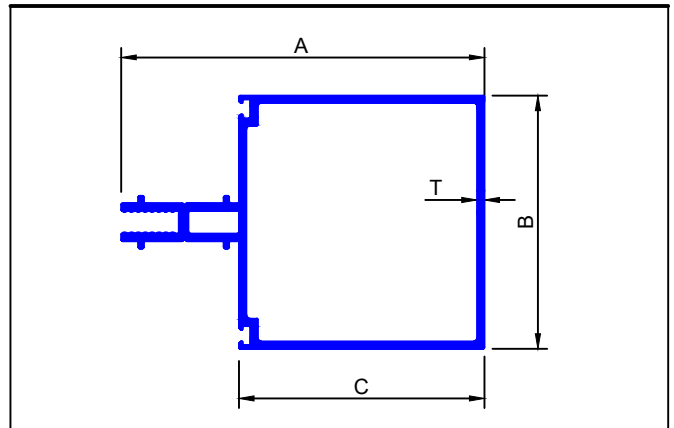

SEC.NO.	A	B	C	T	WT.Kg/mtr.
5734	96.16	67.00	65.00	2.00	1.828

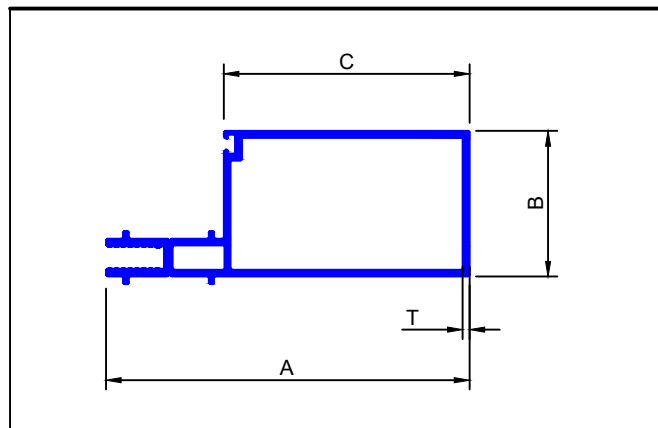

SEC.NO.	A	B	C	T	WT.Kg/mtr.
5735	96.16	38.50	65.00	1.80	1.380

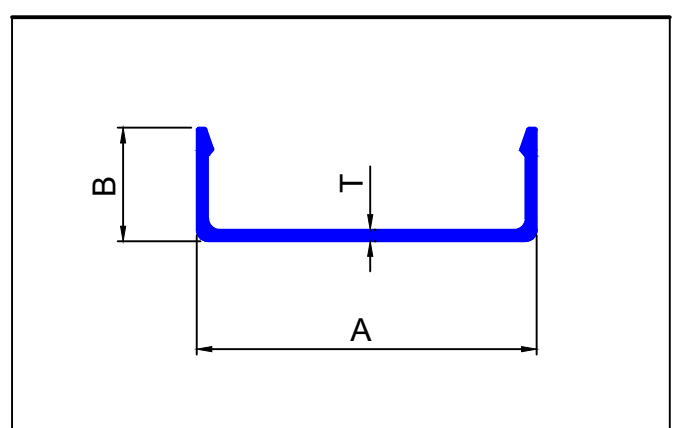

SEC.NO.	A	B	C	T	WT.Kg/mtr.
5736	45.00	15.00	-----	1.50	0.296

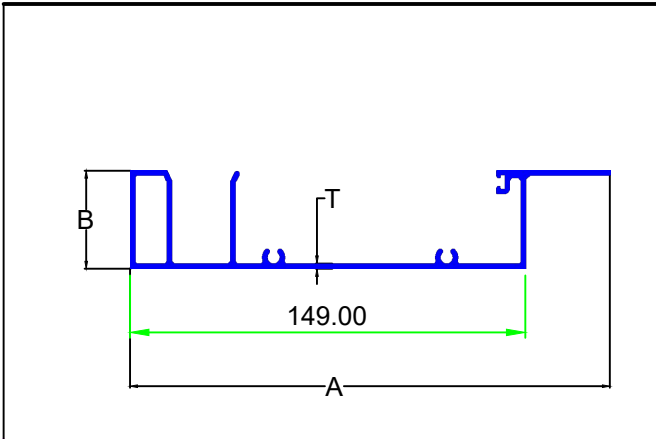

SEC.NO.	A	B	T	WT.Kg/mtr.
3700	180.90	37.00	2.00	2.043

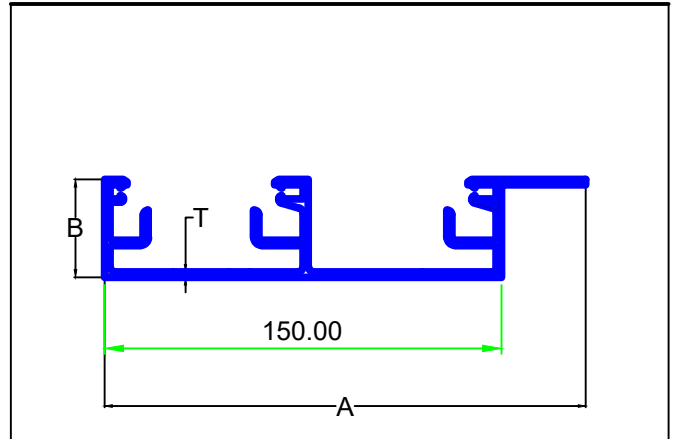

SEC.NO.	A	B	T	WT.Kg/mtr.
3701	181.90	37.00	2.00	2.315

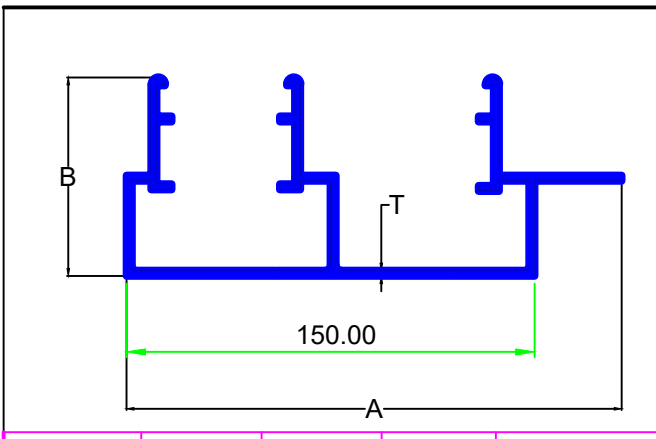

SEC.NO.	A	B	T	WT.Kg/mtr.
3702	182.00	73.00	2.00	2.617

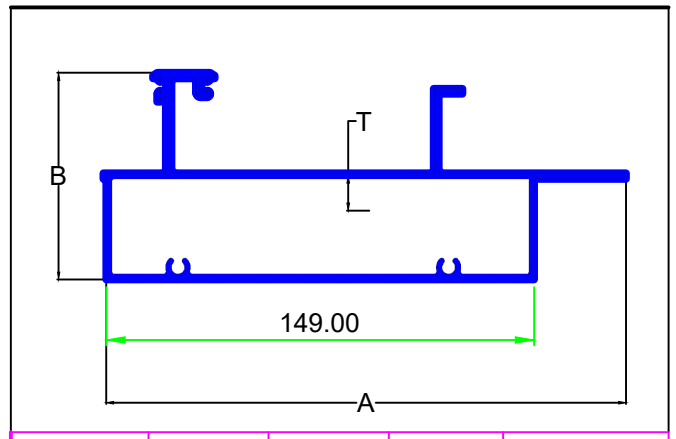

SEC.NO.	A	B	T	WT.Kg/mtr.
3703	181.00	72.00	2.00	2.827

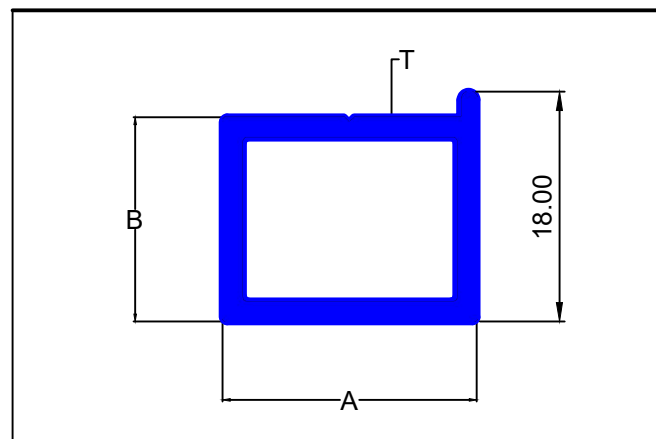

SEC.NO.	A	B	T	WT.Kg/mtr.
3705	20.00	16.00	1.60	0.289

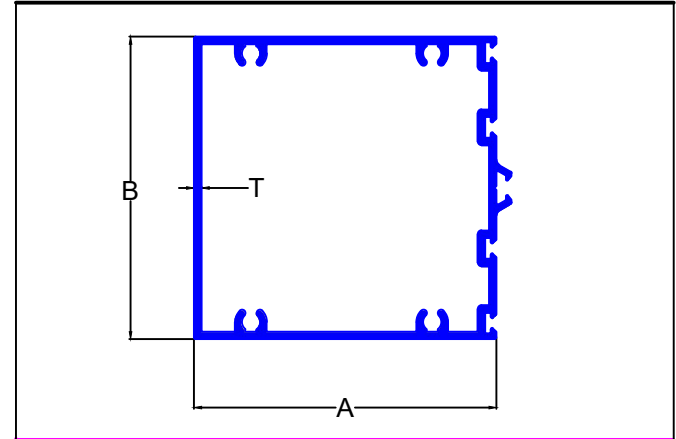

SEC.NO.	A	B	T	WT.Kg/mtr.
3706	80.00	80.00	2.00	2.088

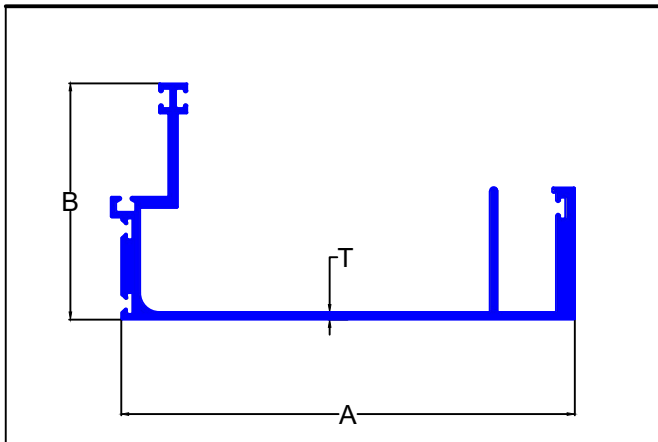

SEC.NO.	A	B	T	WT.Kg/mtr.
3707	119.50	62.20	2.00	1.914

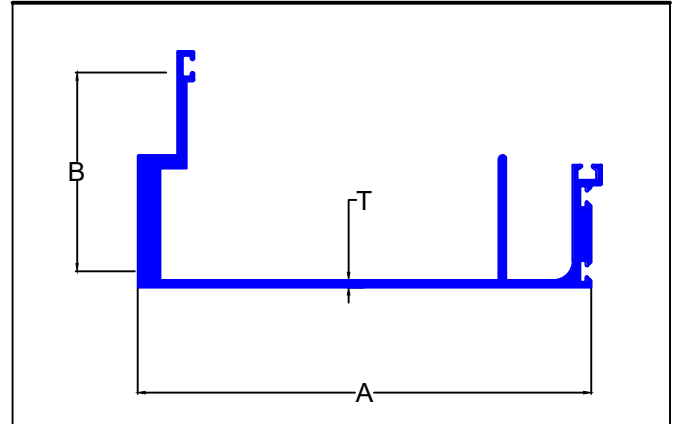

SEC.NO.	A	B	T	WT.Kg/mtr.
3708	120.00	62.50	2.00	1.966

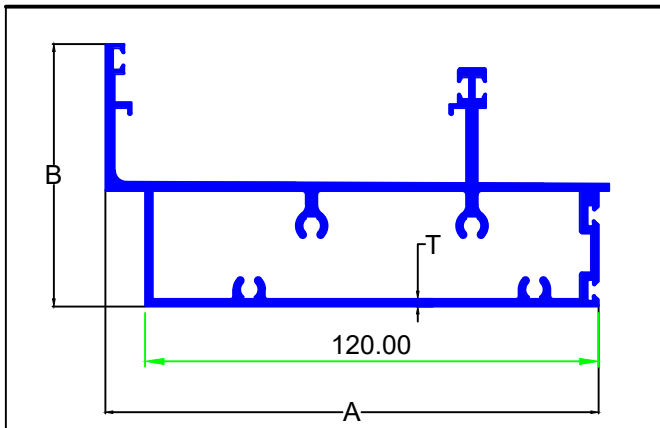

SEC.NO.	A	B	T	WT.Kg/mtr.
3709	130.53	69.43	2.00	2.805

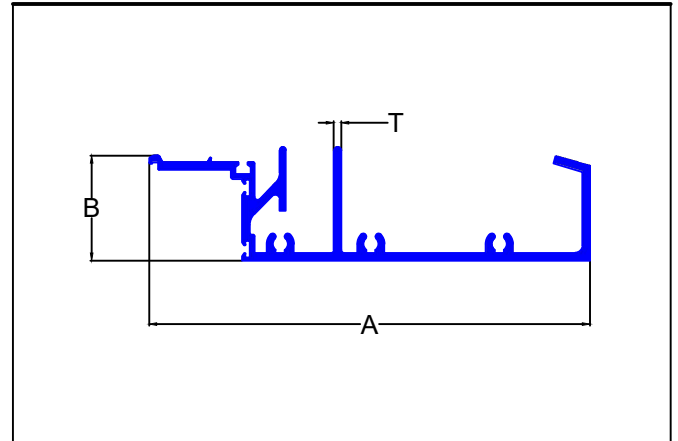

SEC.NO.	A	B	T	WT.Kg/mtr.
3710	145.80	34.73	2.50	2.142

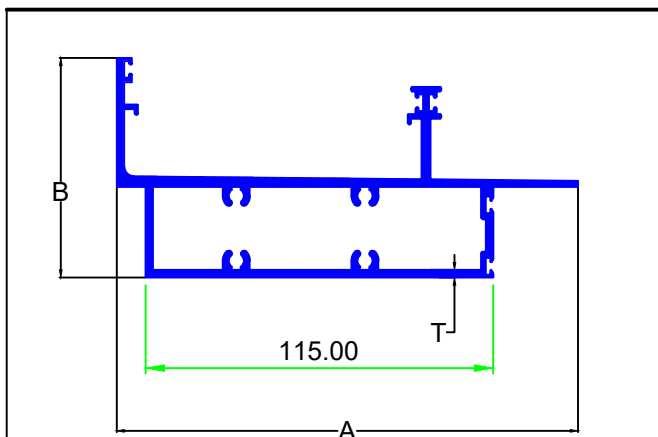

SEC.NO.	A	B	T	WT.Kg/mtr.
3711	152.54	72.58	2.50	3.249

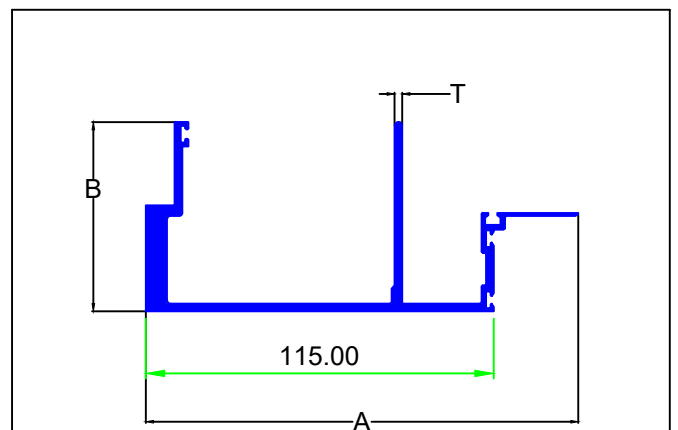

SEC.NO.	A	B	T	WT.Kg/mtr.
3712	143.00	62.50	2.50	2.347

UNITIZED GLAZING

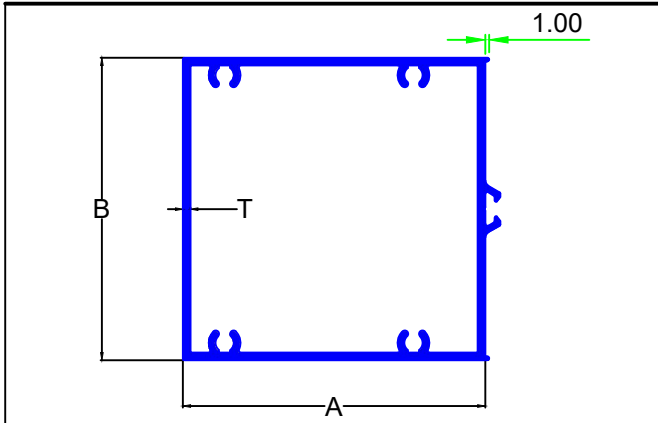

SEC.NO.	A	B	T	WT.Kg/mtr.
3713	80.00	80.00	2.00	1.968

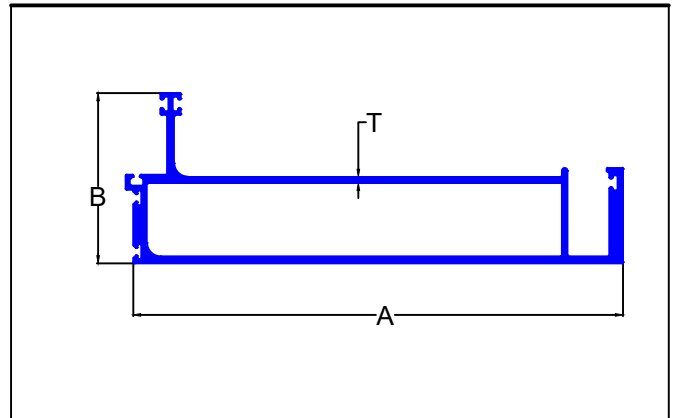

SEC.NO.	A	B	T	WT.Kg/mtr.
3714	180.00	62.50	2.25	3.333

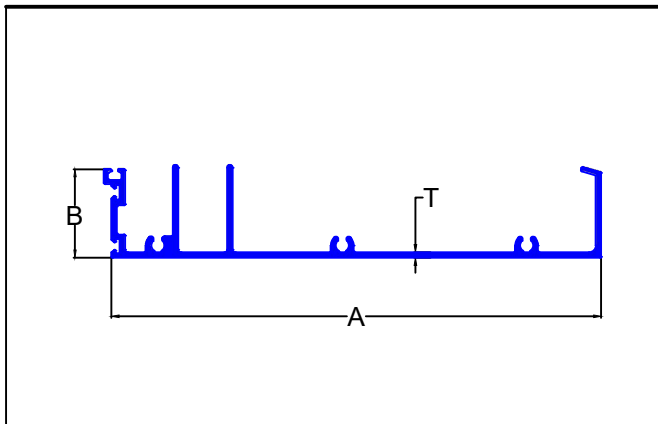

SEC.NO.	A	B	T	WT.Kg/mtr.
3715	180.00	32.50	2.00	1.965

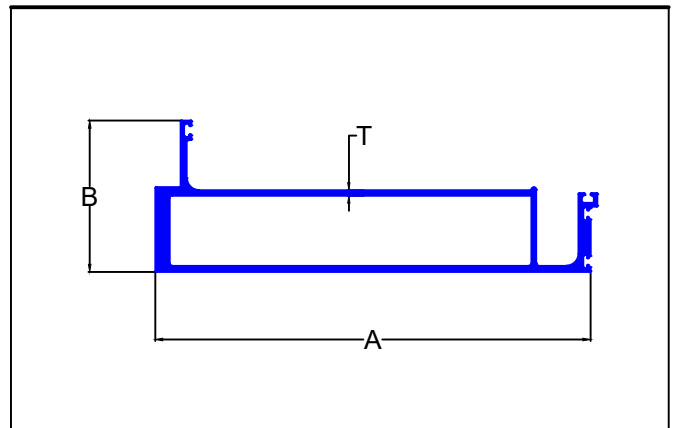

SEC.NO.	A	B	T	WT.Kg/mtr.
3716	180.00	62.50	2.25	3.398

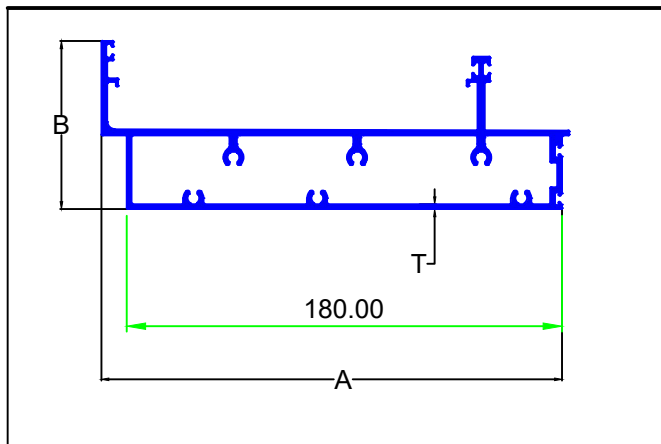

SEC.NO.	A	B	T	WT.Kg/mtr.
3717	190.53	69.43	2.00	3.681

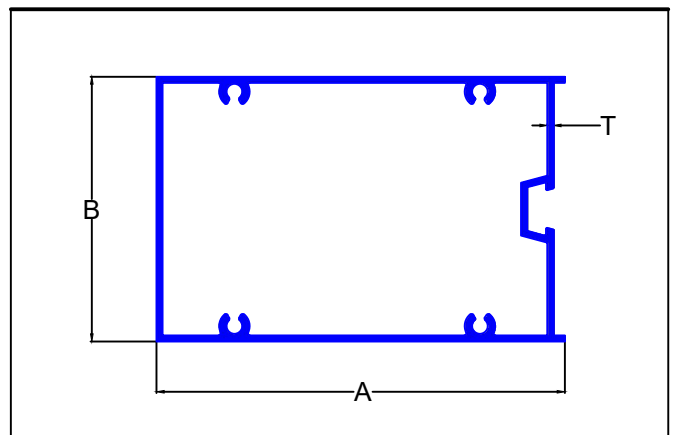

SEC.NO.	A	B	T	WT.Kg/mtr.
3718	108.00	70.00	1.60	1.832

UNITIZED GLAZING

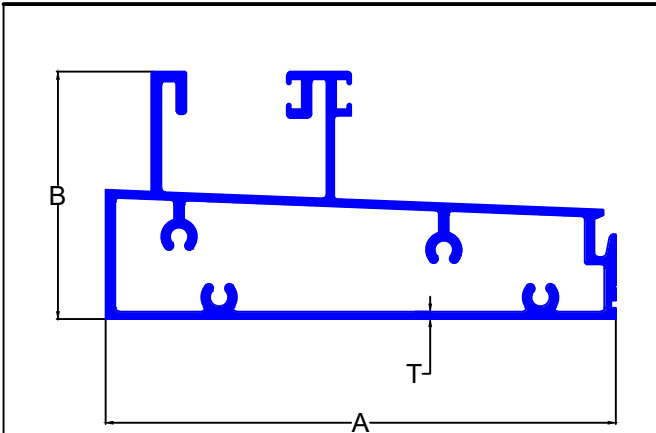

SEC.NO.	A	B	T	WT.Kg/mtr.
3719	135.00	35.50	2.00	3.147

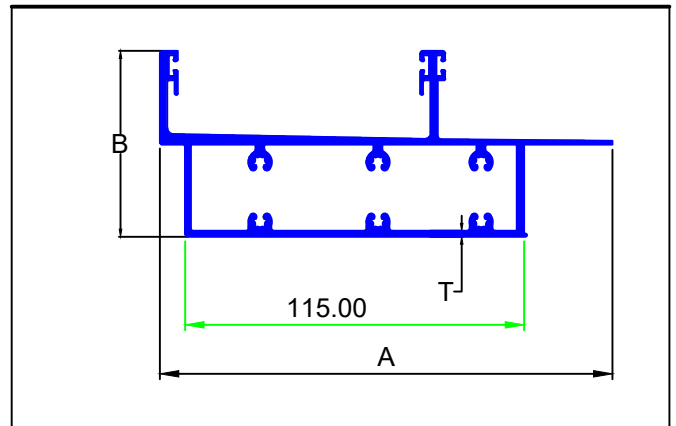

SEC.NO.	A	B	T	WT.Kg/mtr.
3720	153.13	63.00	2.00	3.014

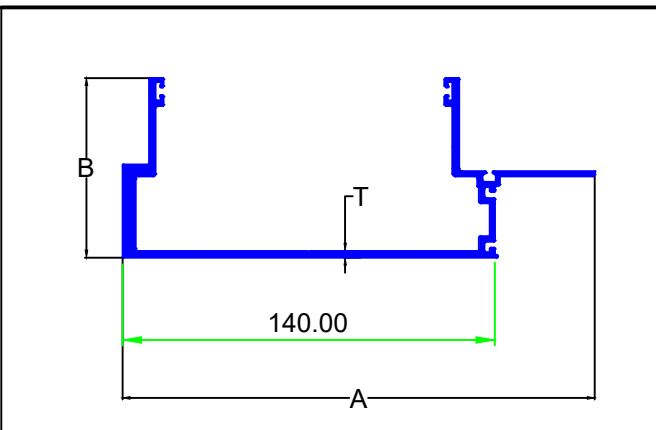

SEC.NO.	A	B	T	WT.Kg/mtr.
3721	177.52	67.50	2.00	2.532

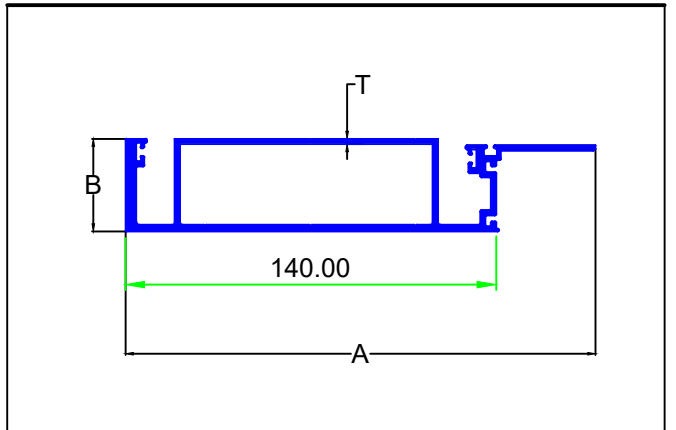

SEC.NO.	A	B	T	WT.Kg/mtr.
3722	177.52	35.00	2.00	2.752

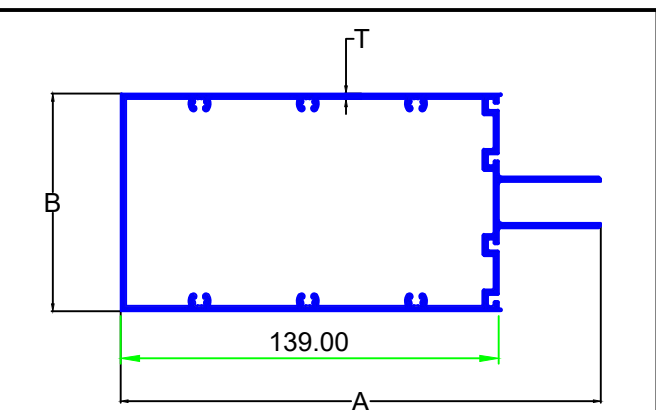

SEC.NO.	A	B	T	WT.Kg/mtr.
3723	176.20	80.00	2.00	3.218

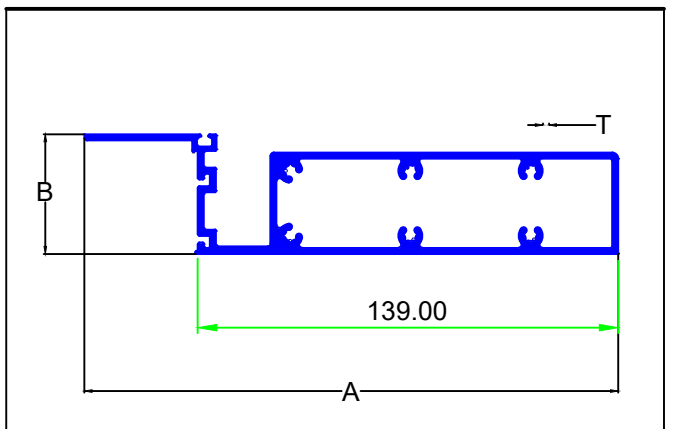

SEC.NO.	A	B	T	WT.Kg/mtr.
3724	176.20	39.57	2.00	2.815

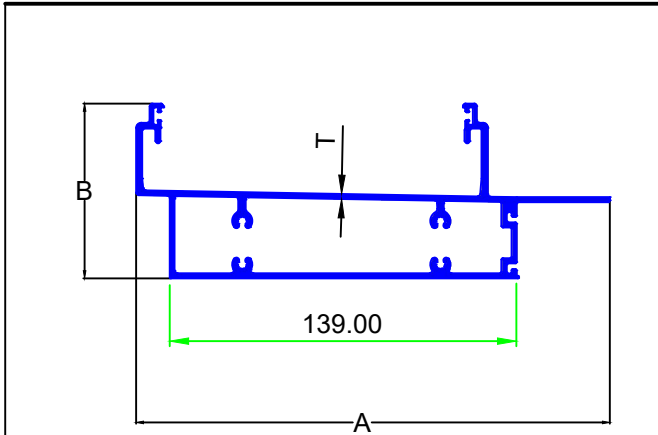

SEC.NO.	A	B	T	WT.Kg/mtr.
3725	190.00	70.00	2.00	3.270

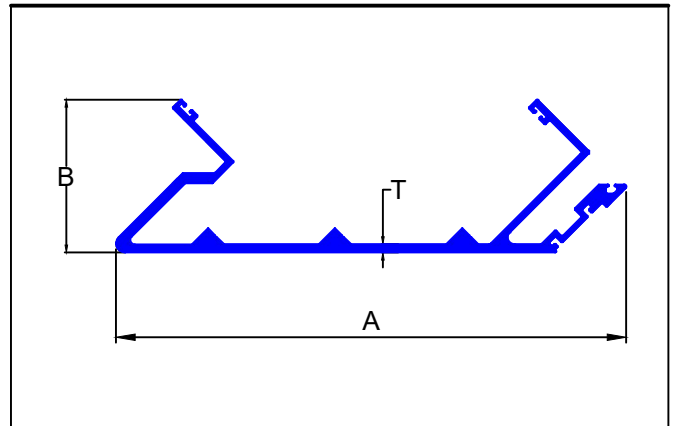

SEC.NO.	A	B	T	WT.Kg/mtr.
3726	224.88	67.30	3.64	4.404

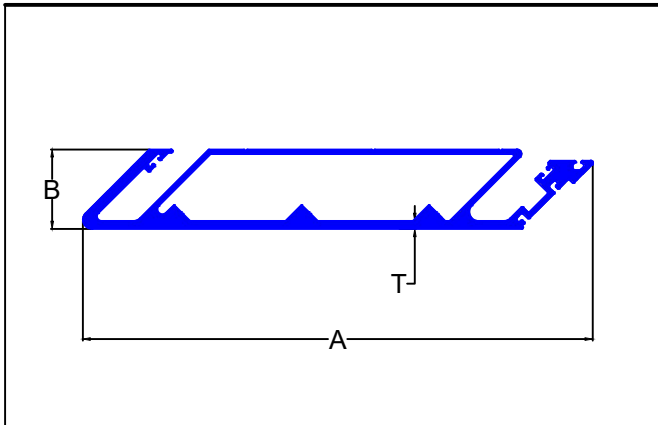

SEC.NO.	A	B	T	WT.Kg/mtr.
3727	224.88	35.00	3.50	4.686

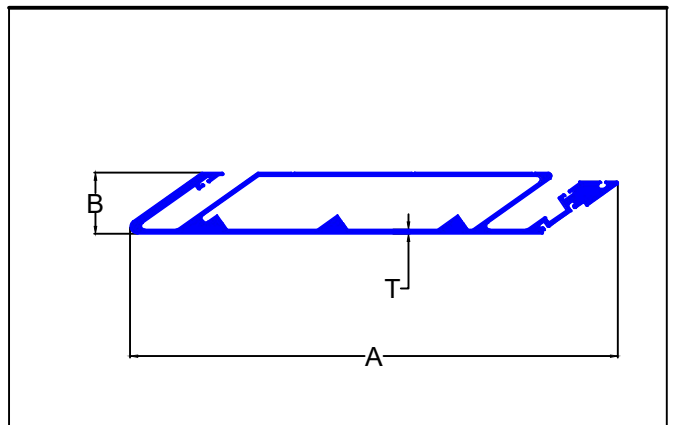

SEC.NO.	A	B	T	WT.Kg/mtr.
3728	279.39	35.00	2.50	5.357

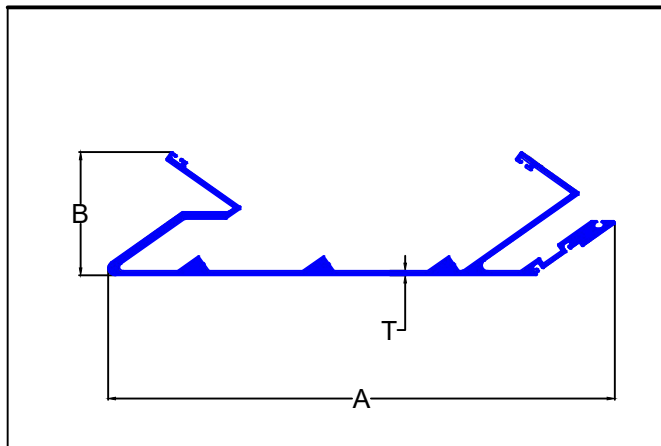

SEC.NO.	A	B	T	WT.Kg/mtr.
3729	279.20	67.96	2.50	4.929

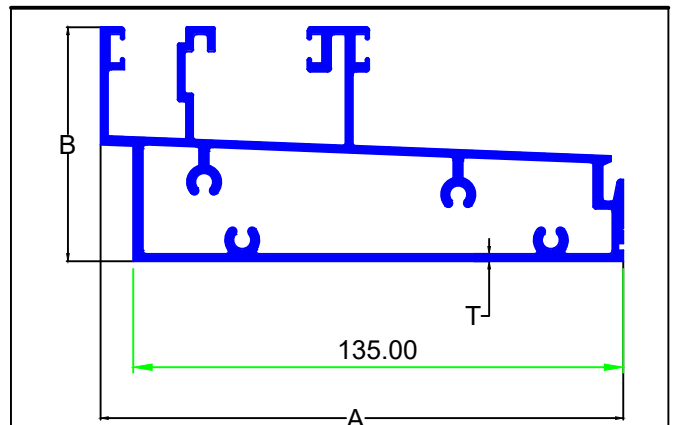

SEC.NO.	A	B	T	WT.Kg/mtr.
3730	144.01	64.50	2.00	3.350

UNITIZED GLAZING

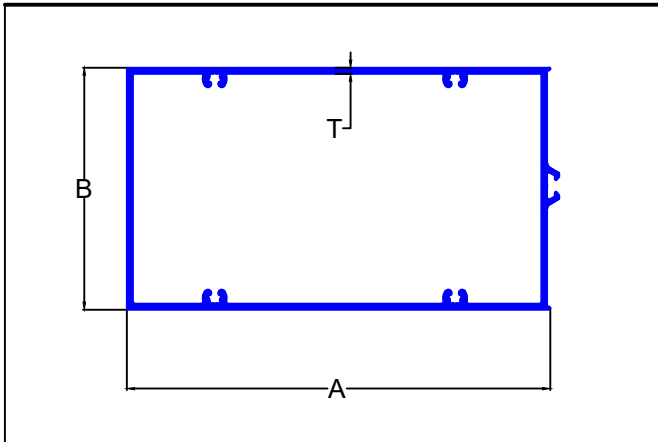

SEC.NO.	A	B	T	WT.Kg/mtr.
3731	140.00	8.00	2.00	2.581

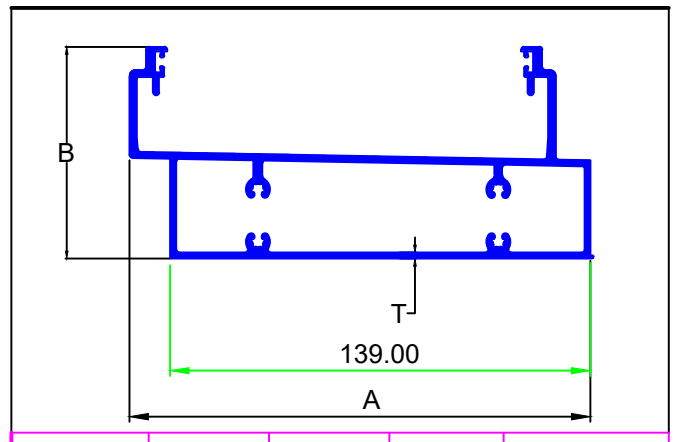

SEC.NO.	A	B	T	WT.Kg/mtr.
3732	152.50	70.00	2.00	3.056

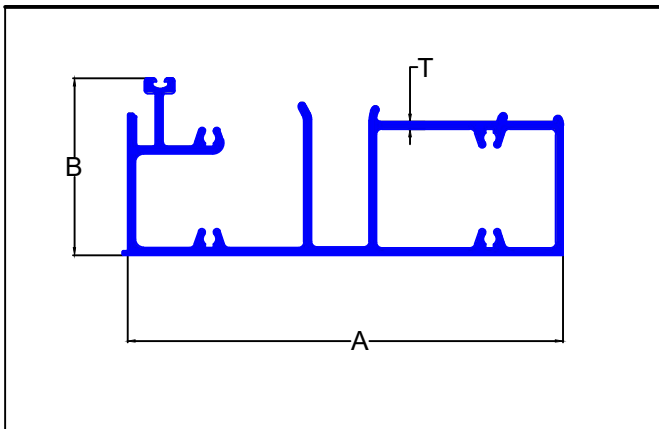

SEC.NO.	A	B	T	WT.Kg/mtr.
3733	160.00	65.00	2.70	4.181

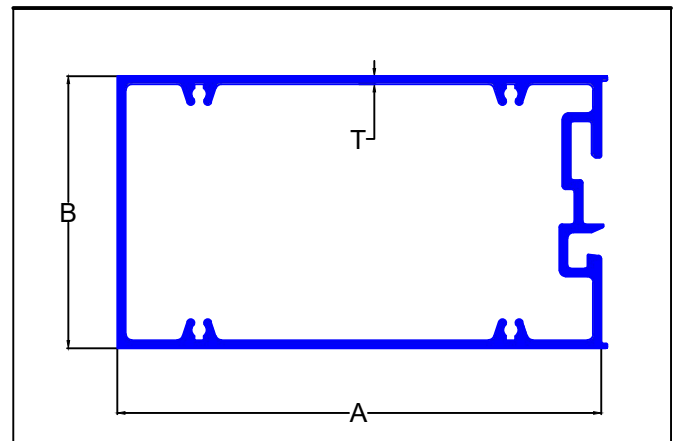

SEC.NO.	A	B	T	WT.Kg/mtr.
3734	160.00	90.00	2.70	4.445

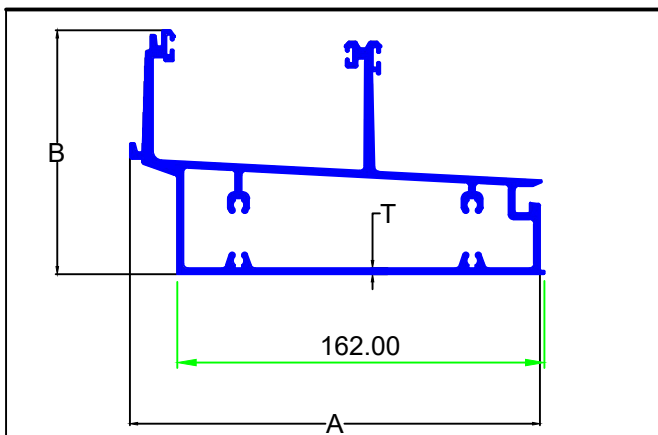

SEC.NO.	A	B	T	WT.Kg/mtr.
3735	182.80	162.00	2.70	5.520

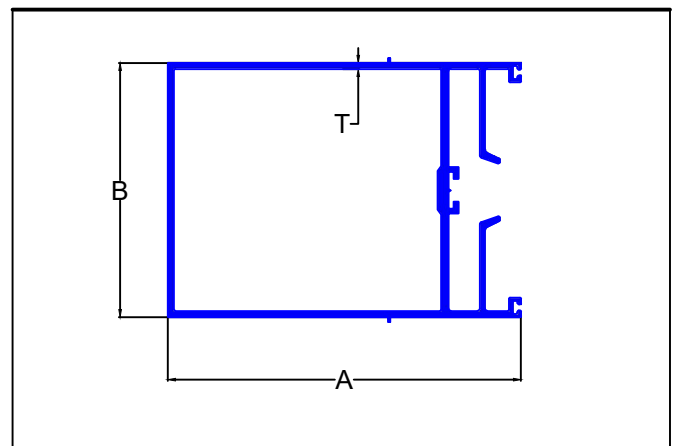

SEC.NO.	A	B	T	WT.Kg/mtr.
3737	146.00	105.00	2.50	4.171

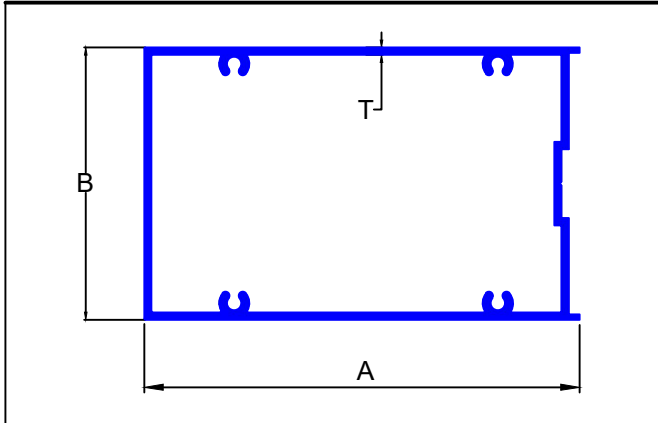

SEC.NO.	A	B	T	WT.Kg/mtr.
3738	120.00	75.00	2.00	2.371

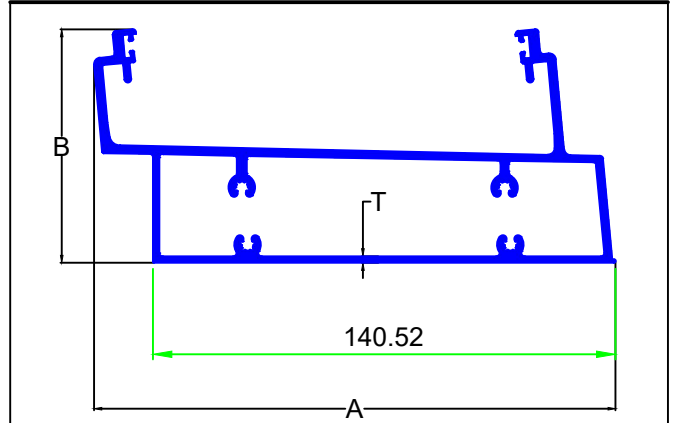

SEC.NO.	A	B	T	WT.Kg/mtr.
3739	158.37	70.91	2.00	3.180

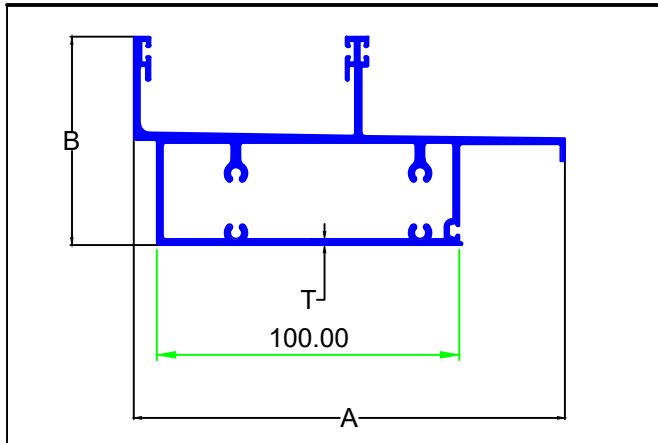

SEC.NO.	A	B	T	WT.Kg/mtr.
3740	142.60	68.94	2.00	2.777

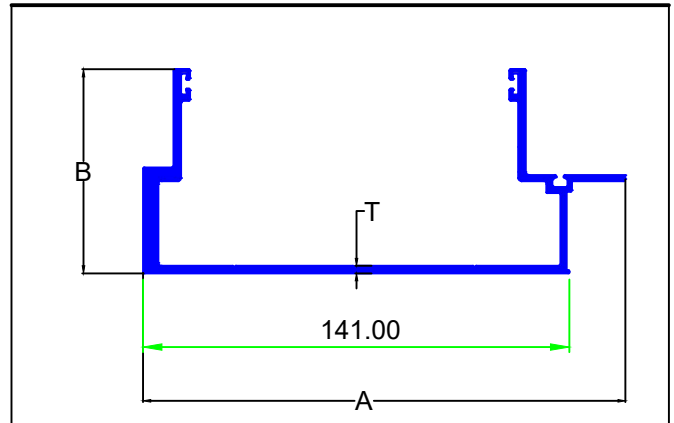

SEC.NO.	A	B	T	WT.Kg/mtr.
3742	159.52	67.50	2.50	2.186

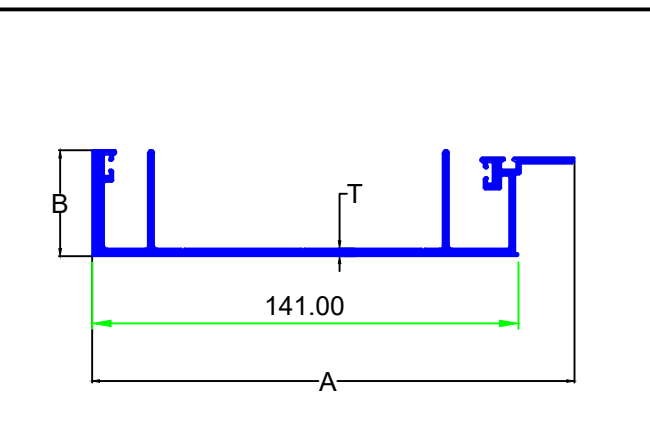

SEC.NO.	A	B	T	WT.Kg/mtr.
3743	159.52	35.00	2.50	2.098

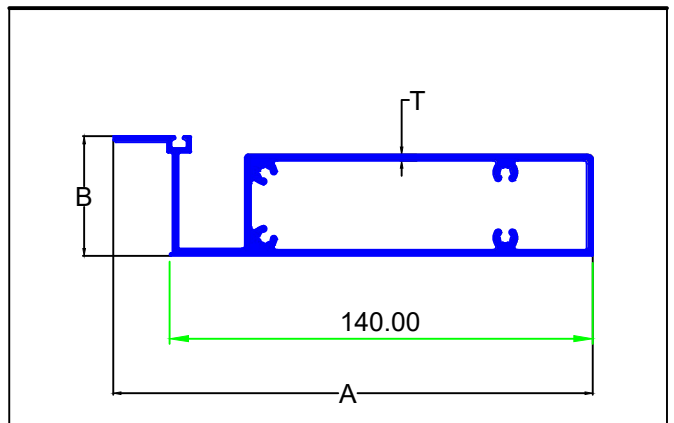

SEC.NO.	A	B	T	WT.Kg/mtr.
3745	158.52	39.57	2.00	3.180

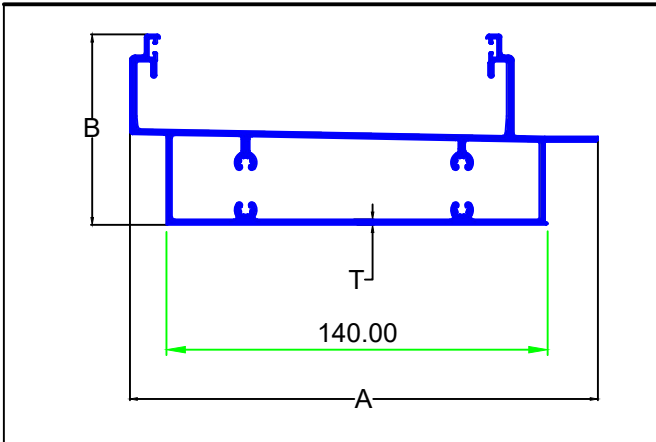

SEC.NO.	A	B	T	WT.Kg/mtr.
3746	172.02	70.00	2.00	2.777

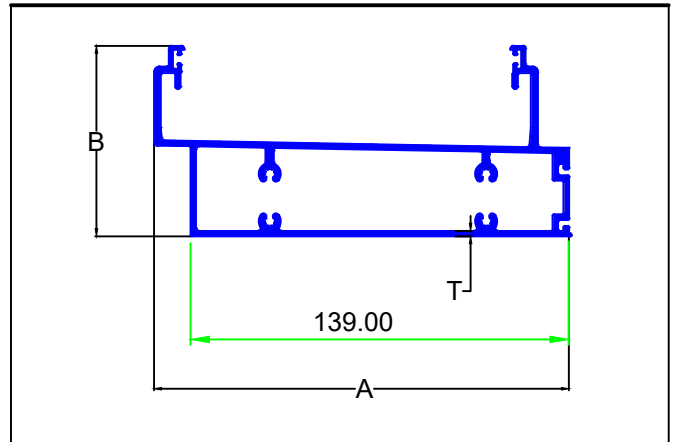

SEC.NO.	A	B	T	WT.Kg/mtr.
3747	152.50	70.00	2.00	3.068

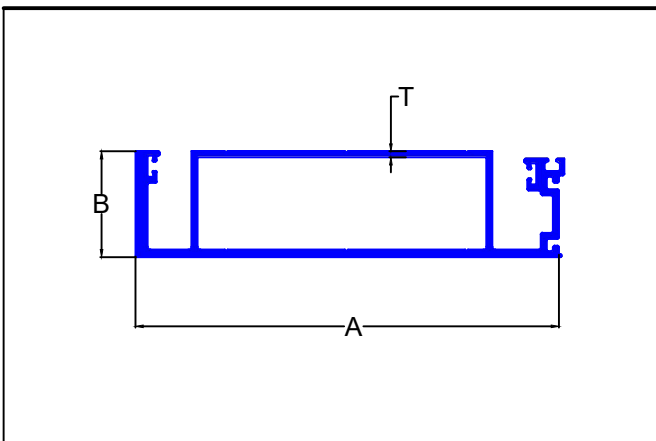

SEC.NO.	A	B	T	WT.Kg/mtr.
3748	140.00	35.00	2.00	2.561

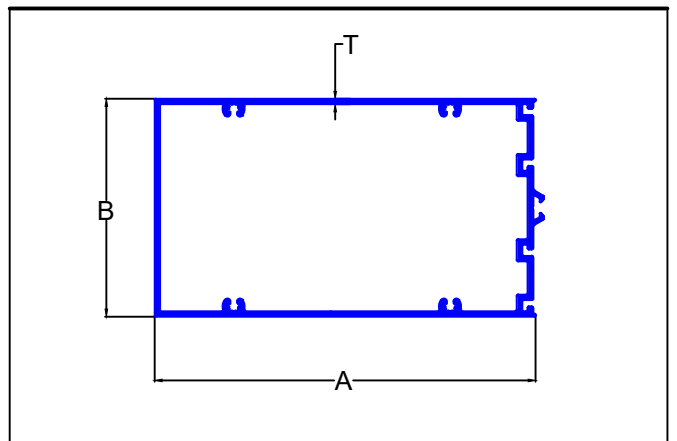

SEC.NO.	A	B	T	WT.Kg/mtr.
3749	140.00	80.00	2.00	2.749

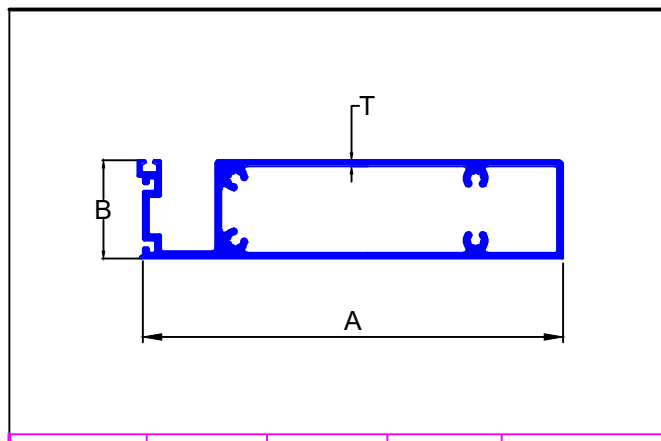

SEC.NO.	A	B	T	WT.Kg/mtr.
3750	139.00	32.50	2.00	2.374

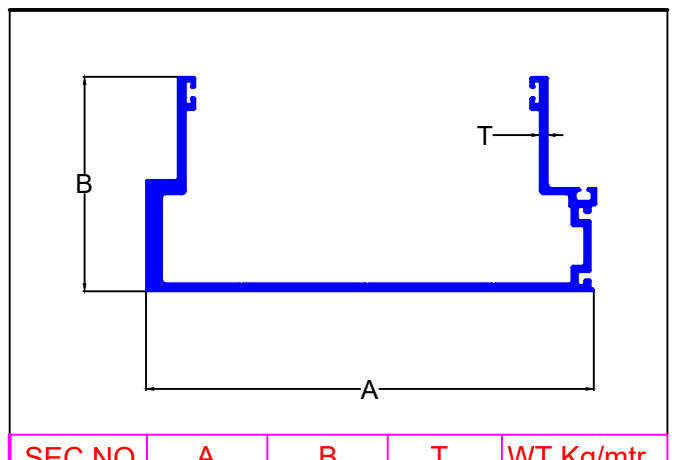

SEC.NO.	A	B	T	WT.Kg/mtr.
3751	141.00	67.50	2.50	2.340

UNITIZED GLAZING

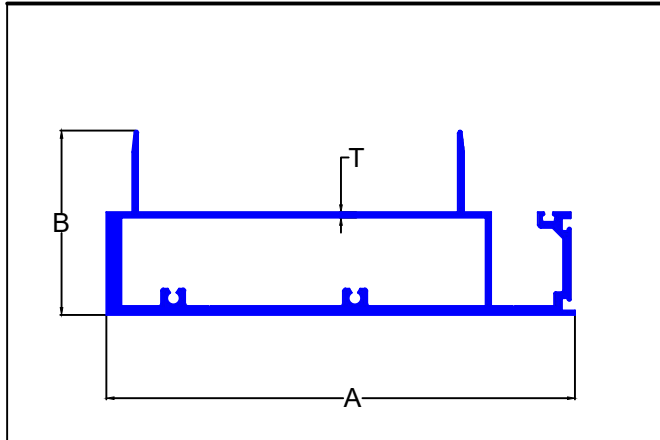

SEC.NO.	A	B	T	WT.Kg/mtr.
3752	155.00	67.00	1.80	3.116

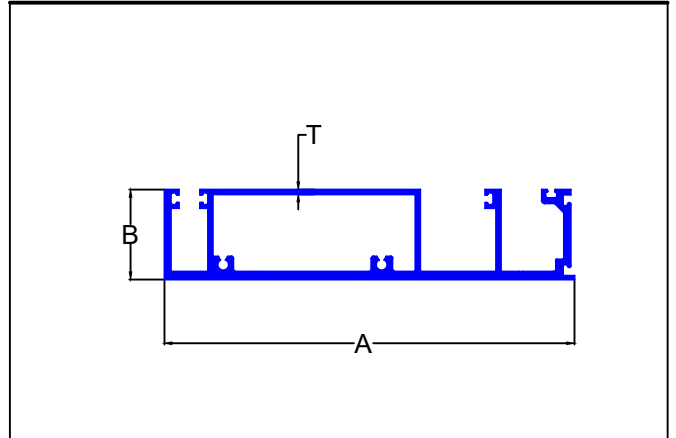

SEC.NO.	A	B	T	WT.Kg/mtr.
3753	155.00	34.00	1.80	2.814

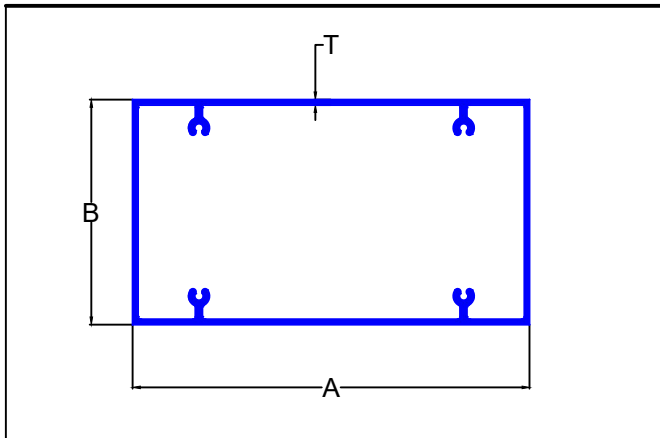

SEC.NO.	A	B	T	WT.Kg/mtr.
3754	150.00	85.00	2.00	2.982

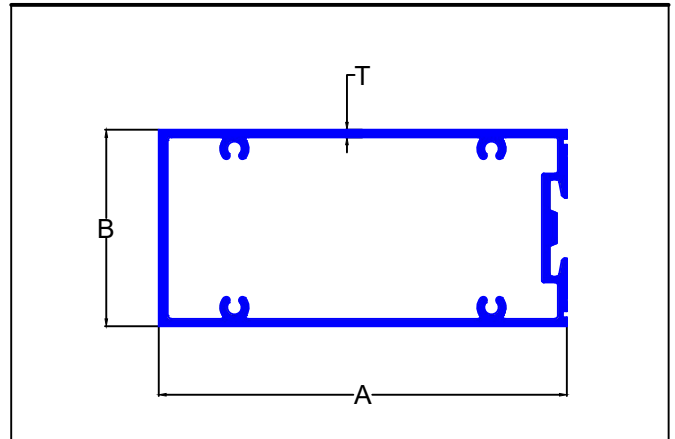

SEC.NO.	A	B	T	WT.Kg/mtr.
3755	135.00	65.00	2.50	3.357

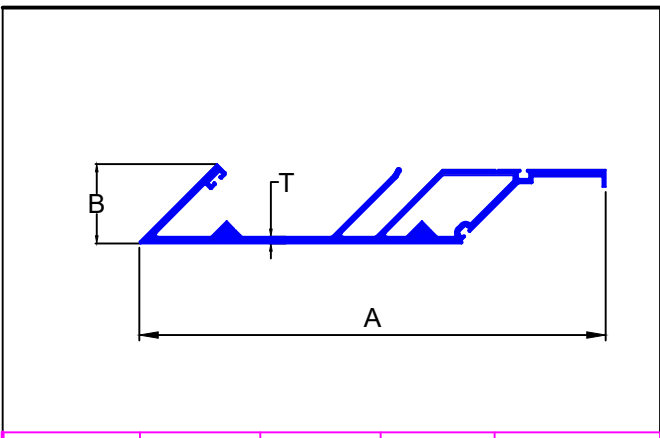

SEC.NO.	A	B	T	WT.Kg/mtr.
3756	205.65	35.00	3.00	3.022

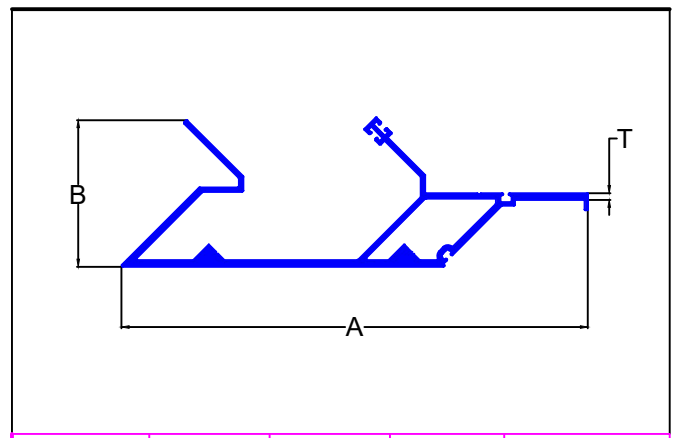

SEC.NO.	A	B	T	WT.Kg/mtr.
3757	205.65	64.68	3.00	3.329

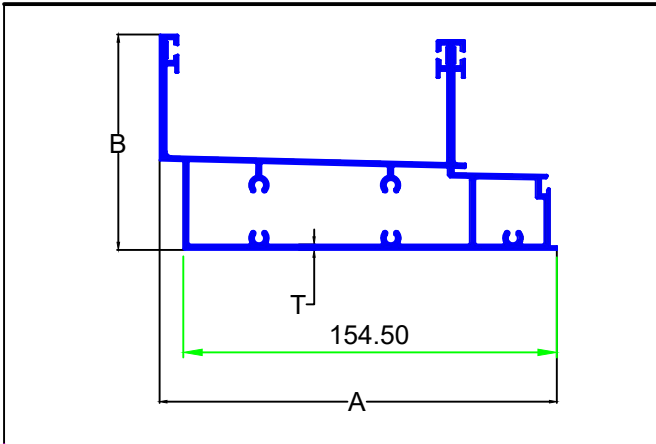

SEC.NO.	A	B	T	WT.Kg/mtr.
3758	164.30	88.95	2.20	3.906

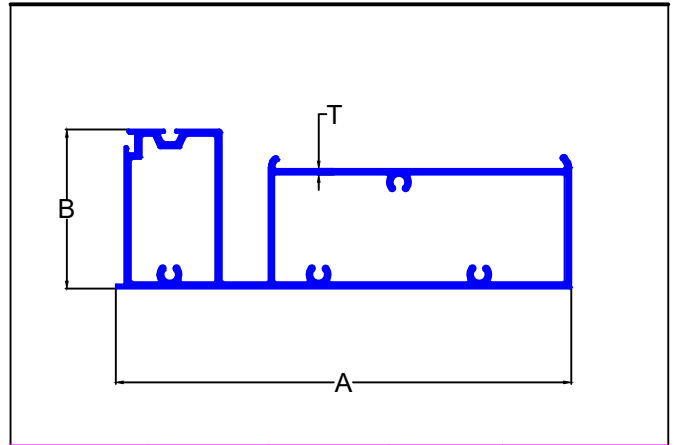

SEC.NO.	A	B	T	WT.Kg/mtr.
3759	154.50	53.95	2.00	3.044

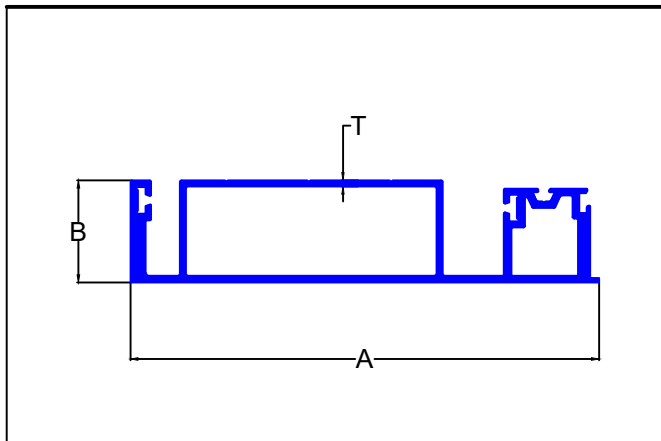

SEC.NO.	A	B	T	WT.Kg/mtr.
3760	155.00	33.75	2.00	2.825

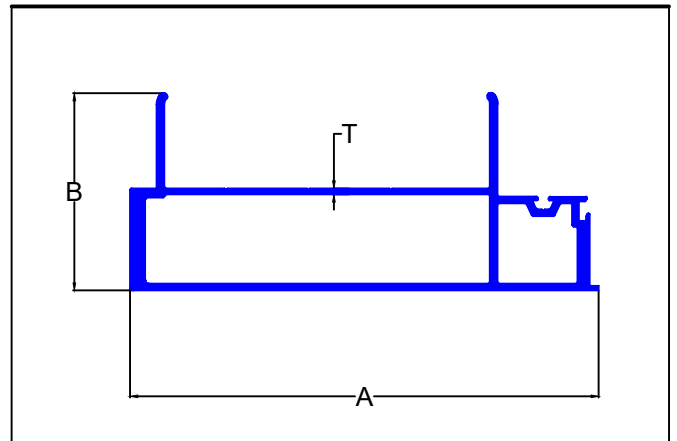

SEC.NO.	A	B	T	WT.Kg/mtr.
3761	155.00	65.20	2.00	3.140

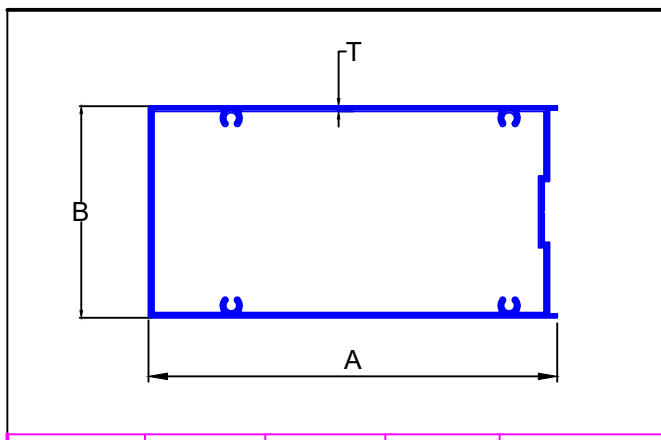

SEC.NO.	A	B	T	WT.Kg/mtr.
3762	154.50	80.00	2.00	2.773

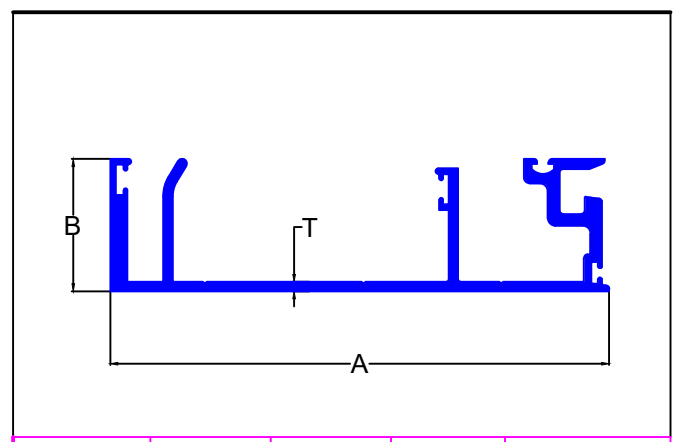

SEC.NO.	A	B	T	WT.Kg/mtr.
3763	132.00	35.00	2.50	2.240

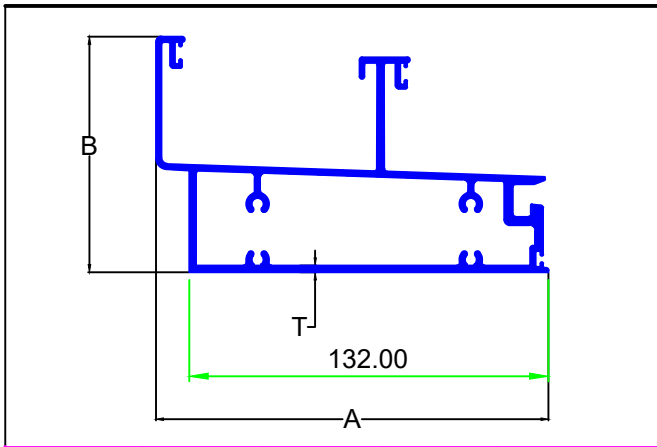

SEC.NO.	A	B	T	WT.Kg/mtr.
3764	144.25	86.53	2.50	3.540

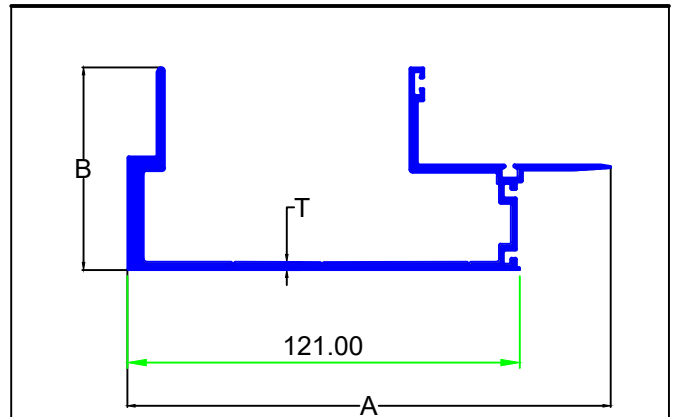

SEC.NO.	A	B	T	WT.Kg/mtr.
3765	149.00	62.49	2.50	2.268

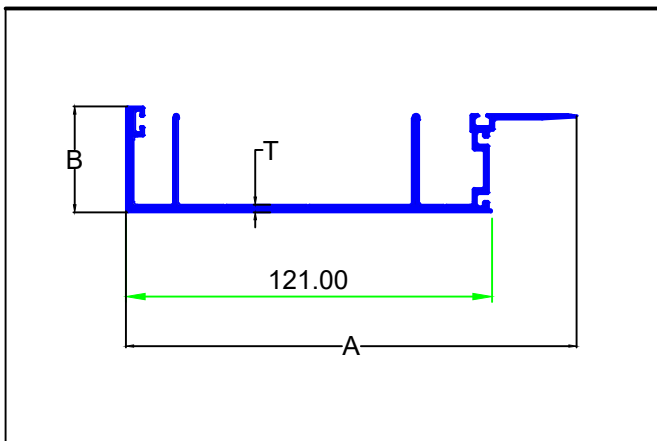

SEC.NO.	A	B	T	WT.Kg/mtr.
3766	149.00	35.00	2.50	1.780

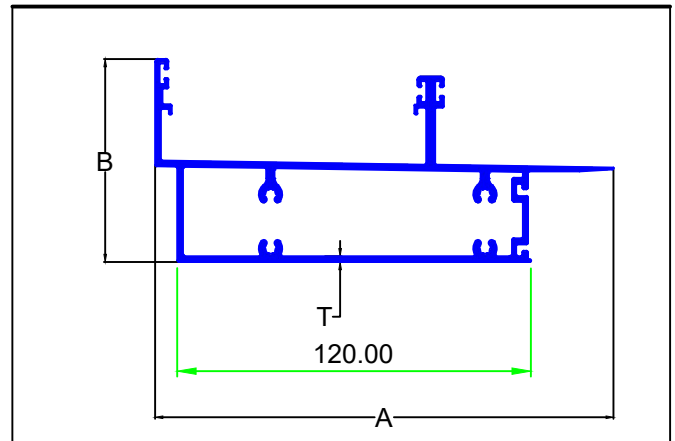

SEC.NO.	A	B	T	WT.Kg/mtr.
3767	155.50	68.80	2.00	2.752

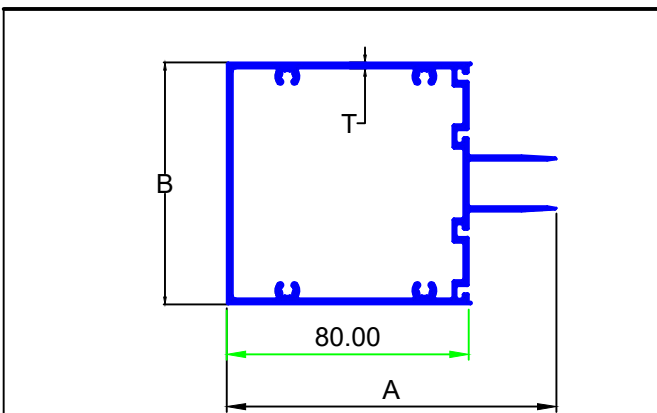

SEC.NO.	A	B	T	WT.Kg/mtr.
3768	109.00	80.00	2.00	2.306

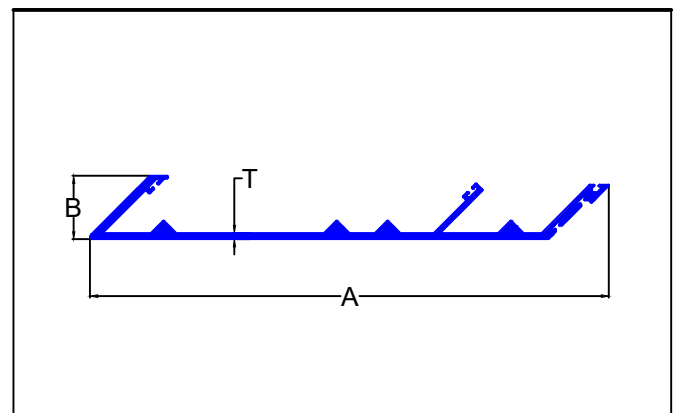

SEC.NO.	A	B	T	WT.Kg/mtr.
3769	285.98	35.00	3.50	4.247

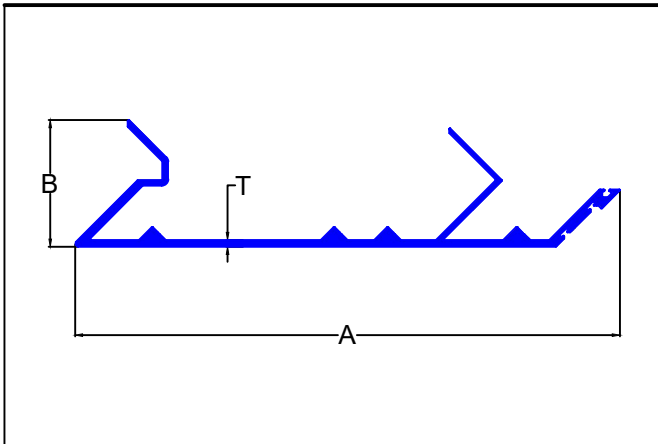

SEC.NO.	A	B	T	WT.Kg/mtr.
3770	285.98	66.49	3.50	4.808

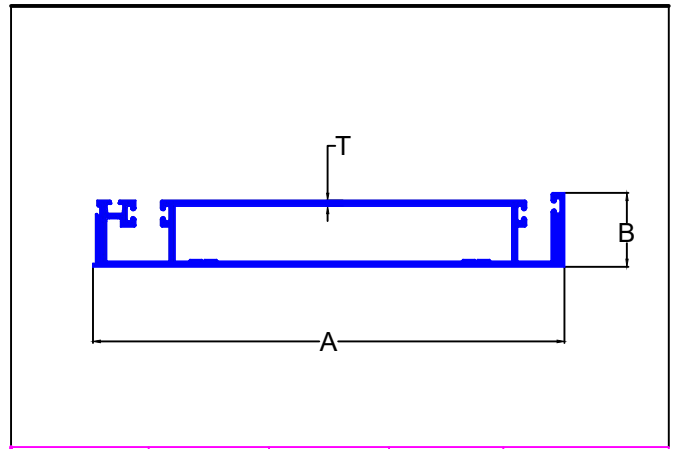

SEC.NO.	A	B	T	WT.Kg/mtr.
3771	160.00	25.00	1.80	2.186

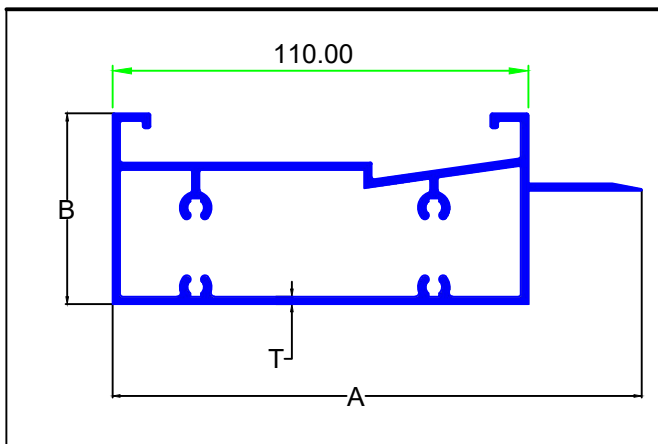

SEC.NO.	A	B	T	WT.Kg/mtr.
3772	140.00	50.50	2.00	2.326

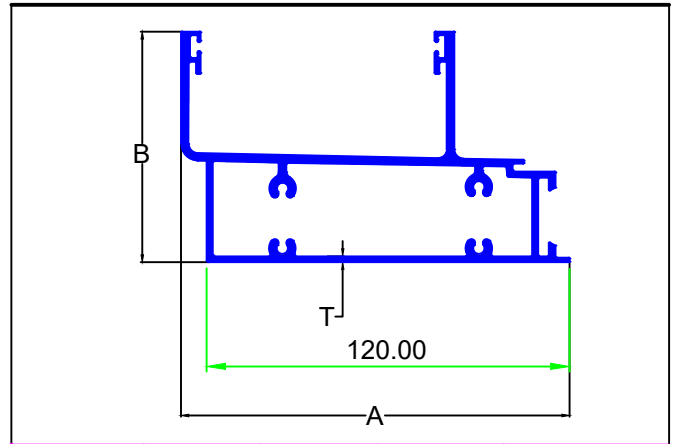

SEC.NO.	A	B	T	WT.Kg/mtr.
3773	128.50	76.30	2.00	2.946

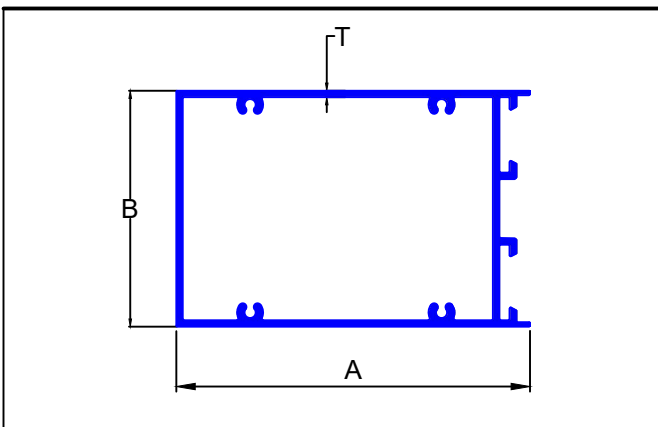

SEC.NO.	A	B	T	WT.Kg/mtr.
3774	120.00	79.97	2.19	2.786

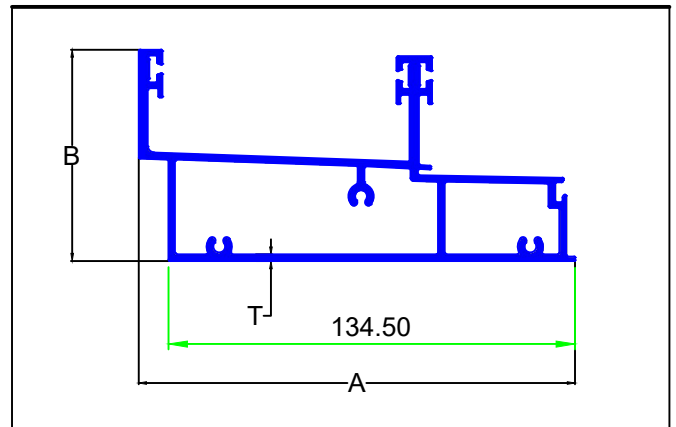

SEC.NO.	A	B	T	WT.Kg/mtr.
3775	144.30	69.90	2.20	4.247

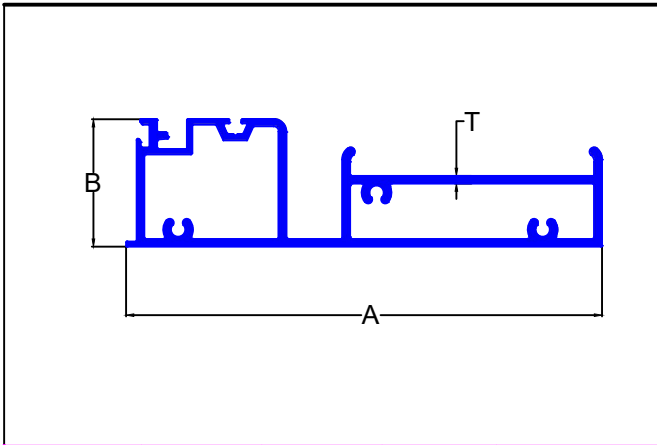

SEC.NO.	A	B	T	WT.Kg/mtr.
3776	134.50	36.00	2.20	2.413

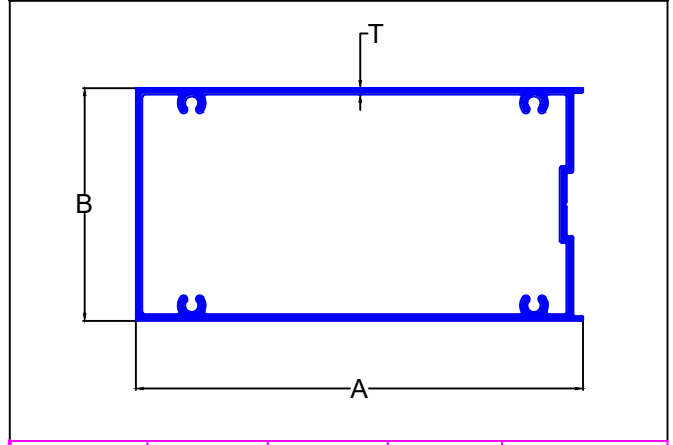

SEC.NO.	A	B	T	WT.Kg/mtr.
3777	134.50	70.00	2.00	2.476

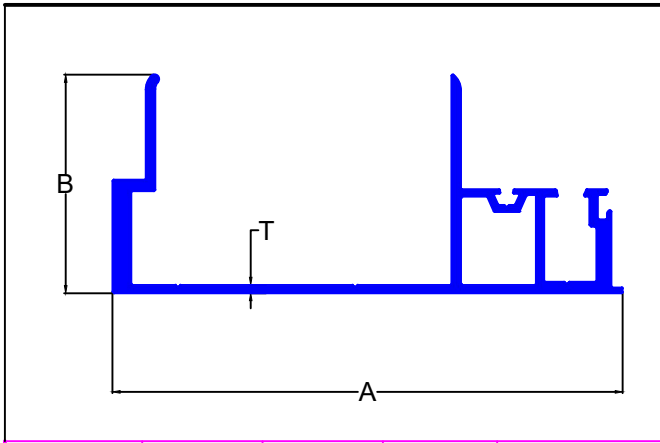

SEC.NO.	A	B	T	WT.Kg/mtr.
3778	135.00	57.80	2.20	2.379

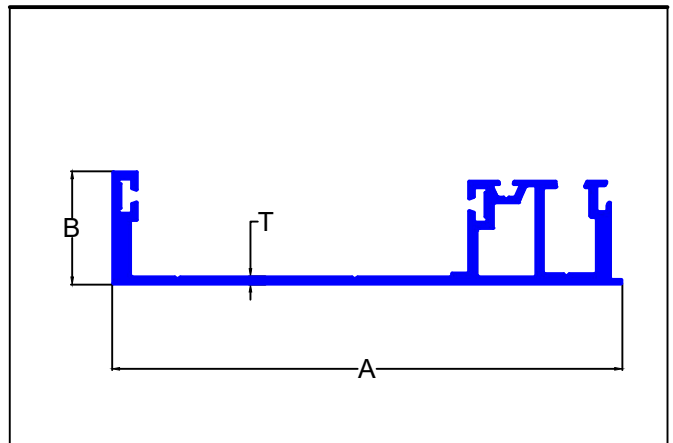

SEC.NO.	A	B	T	WT.Kg/mtr.
3779	135.00	30.00	2.20	1.954

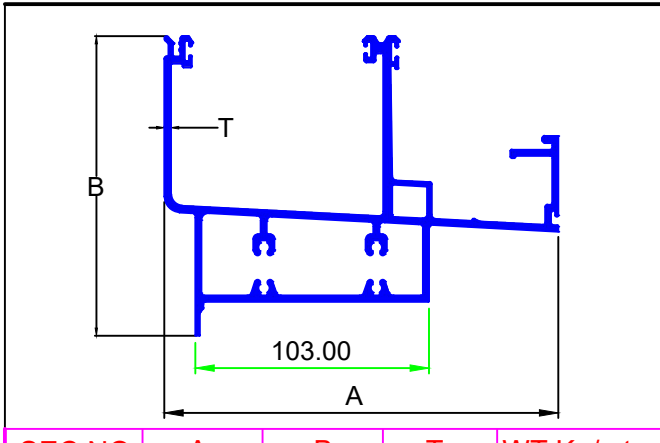

SEC.NO.	A	B	T	WT.Kg/mtr.
3780	160.00	132.00	3.00	5.661

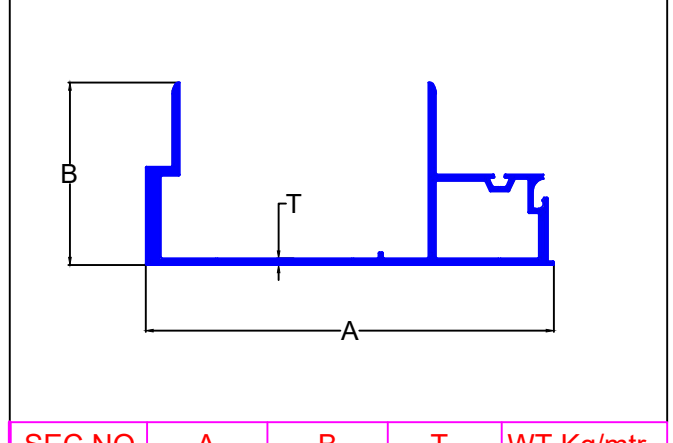

SEC.NO.	A	B	T	WT.Kg/mtr.
3781	135.00	60.30	2.20	2.258

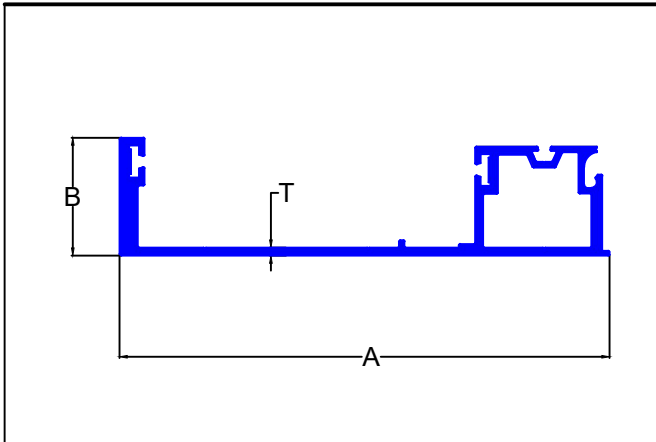

SEC.NO.	A	B	T	WT.Kg/mtr.
3782	135.00	32.50	2.20	1.833

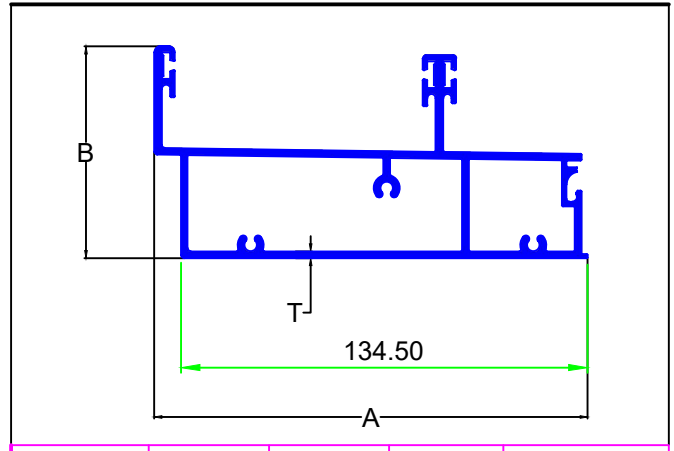

SEC.NO.	A	B	T	WT.Kg/mtr.
3783	143.33	70.00	2.20	3.203

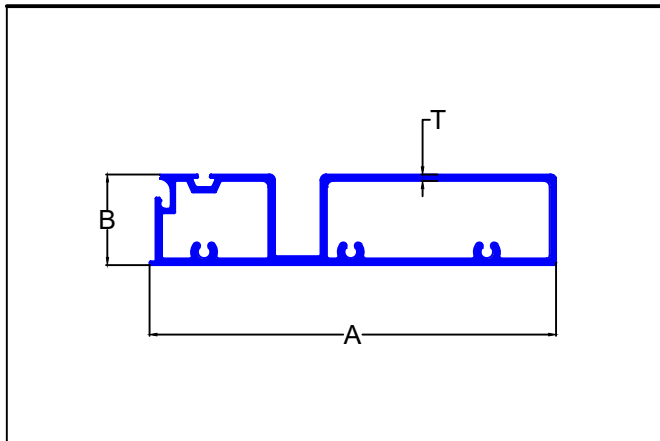

SEC.NO.	A	B	T	WT.Kg/mtr.
3784	134.50	30.00	2.20	2.369

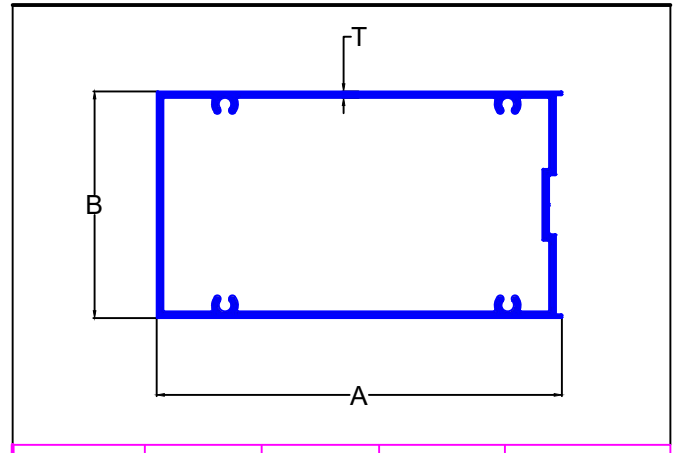

SEC.NO.	A	B	T	WT.Kg/mtr.
3785	134.00	75.00	2.20	2.708

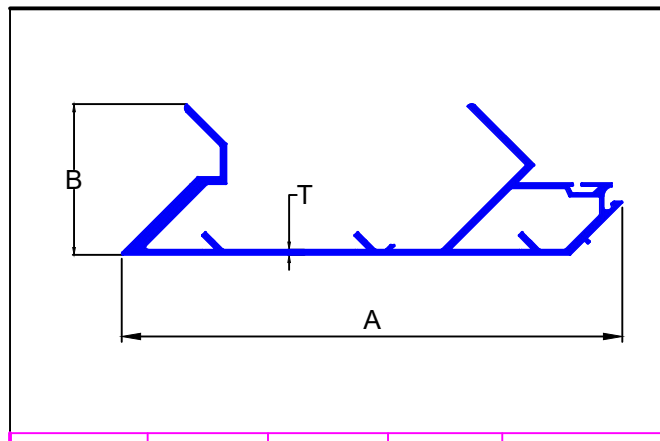

SEC.NO.	A	B	T	WT.Kg/mtr.
3786	209.12	62.96	2.20	3.291

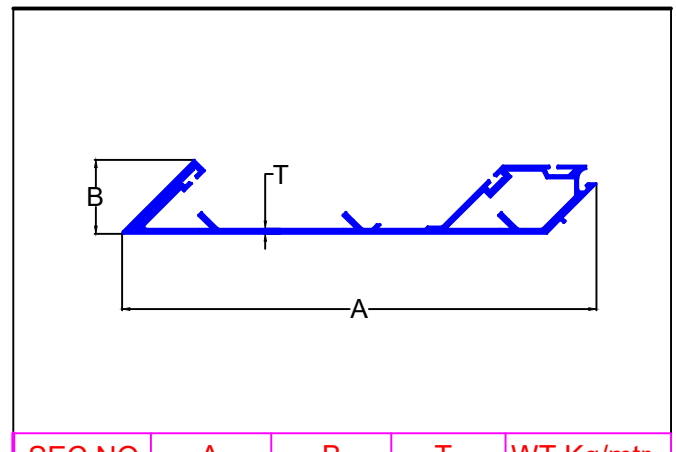

SEC.NO.	A	B	T	WT.Kg/mtr.
3787	209.12	32.50	2.20	2.671

UNITIZED GLAZING

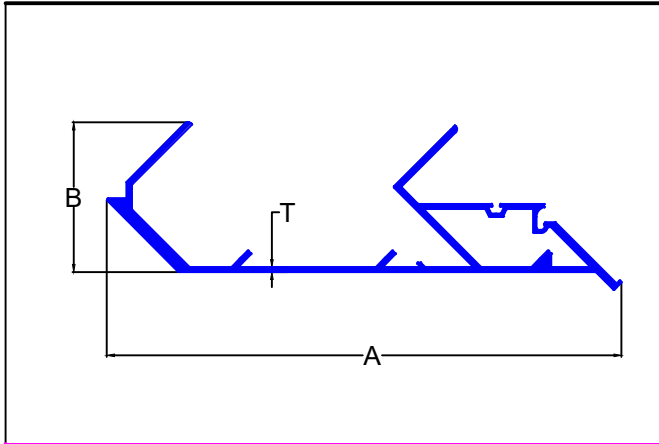

SEC.NO.	A	B	T	WT.Kg/mtr.
3788	226.95	65.96	2.20	3.567

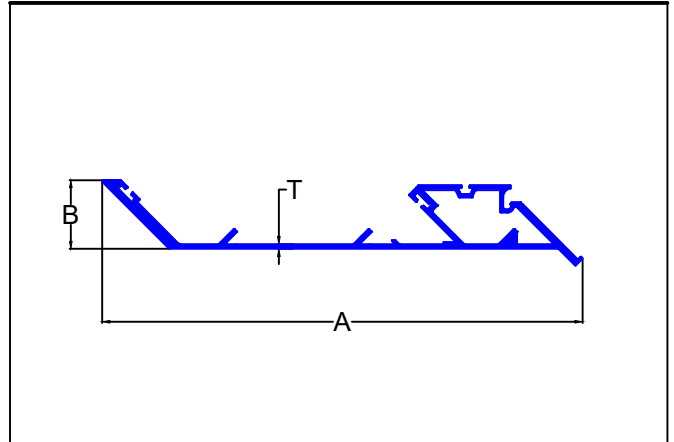

SEC.NO.	A	B	T	WT.Kg/mtr.
3789	226.93	32.48	2.20	2.870

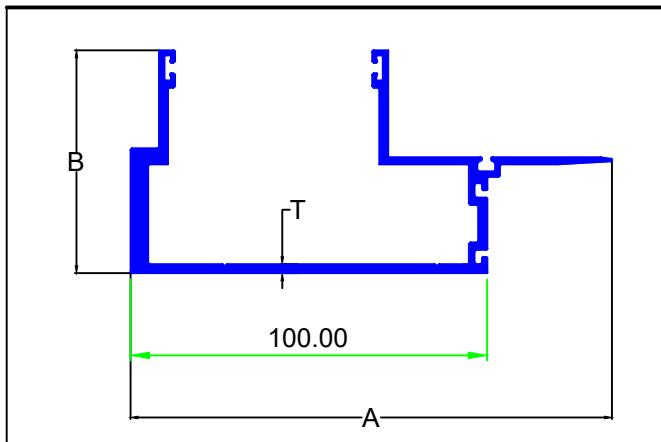

SEC.NO.	A	B	T	WT.Kg/mtr.
3790	135.00	62.50	2.50	2.161

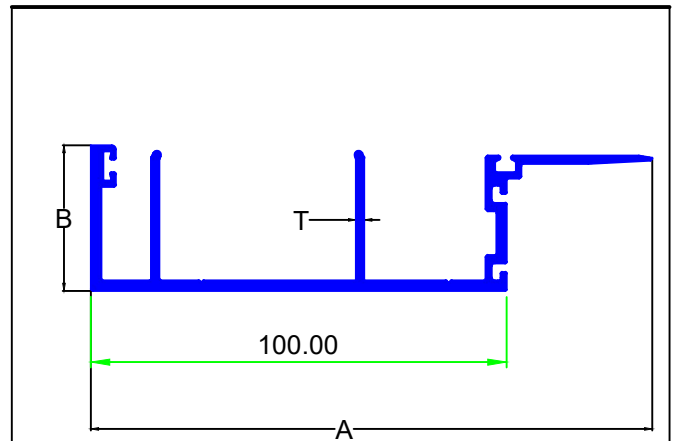

SEC.NO.	A	B	T	WT.Kg/mtr.
3791	135.00	35.00	2.50	1.710

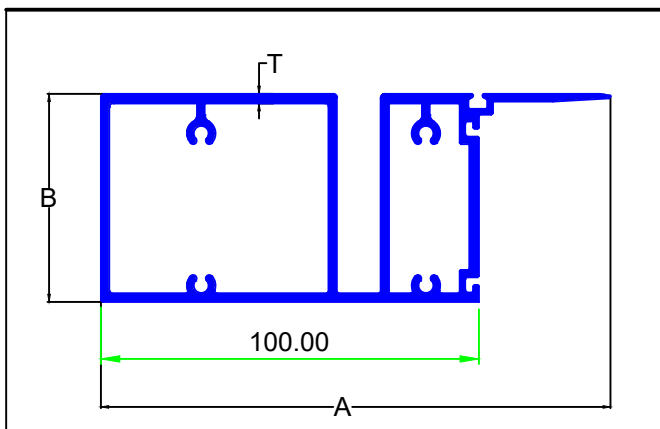

SEC.NO.	A	B	T	WT.Kg/mtr.
3793	134.85	55.00	2.50	2.959

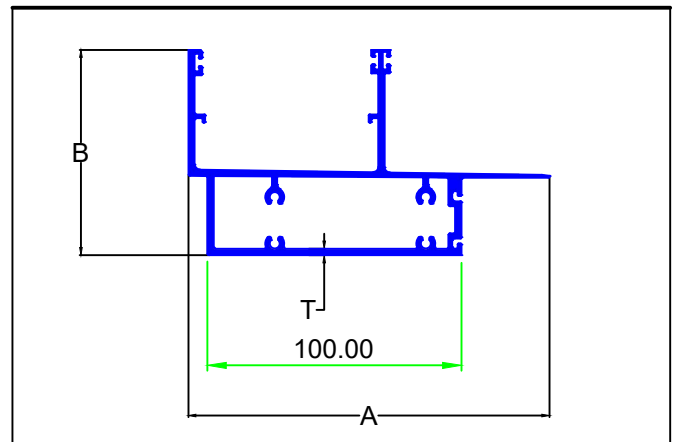

SEC.NO.	A	B	T	WT.Kg/mtr.
3794	142.20	80.80	2.50	2.900

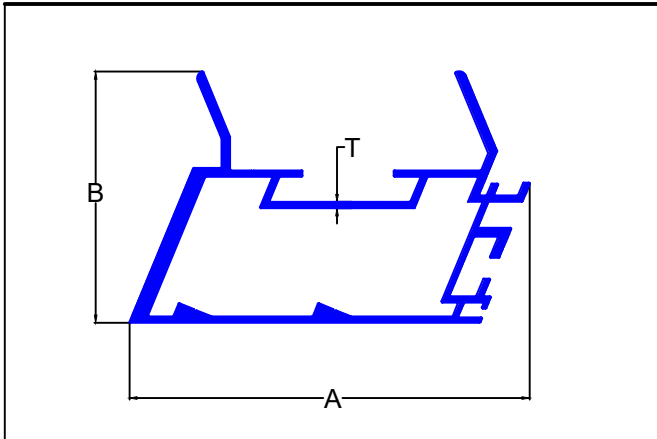

SEC.NO.	A	B	T	WT.Kg/mtr.
3795	135.73	85.20	2.20	3.663

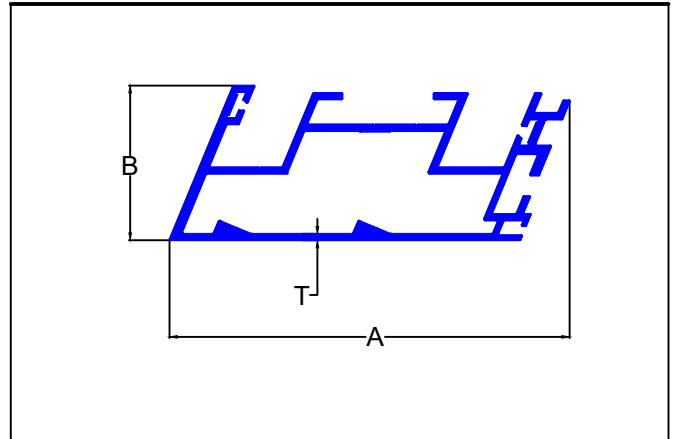

SEC.NO.	A	B	T	WT.Kg/mtr.
3796	135.73	52.50	2.20	3.066

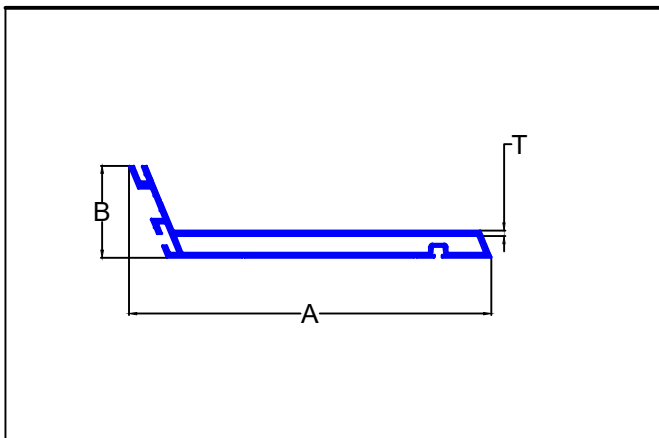

SEC.NO.	A	B	T	WT.Kg/mtr.
3797	159.79	40.50	2.50	2.262

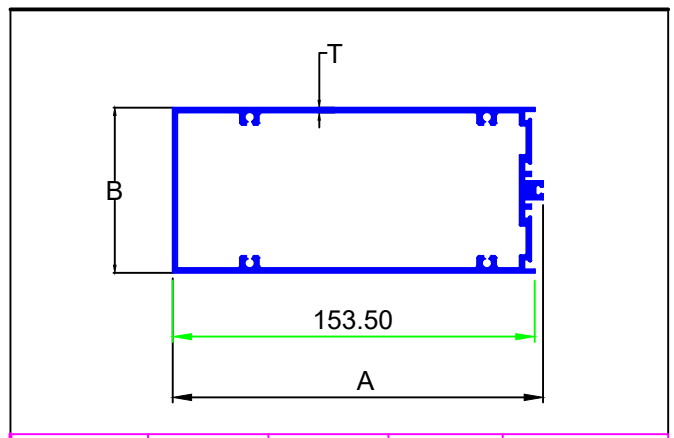

SEC.NO.	A	B	T	WT.Kg/mtr.
3798	157.00	70.00	2.00	2.875

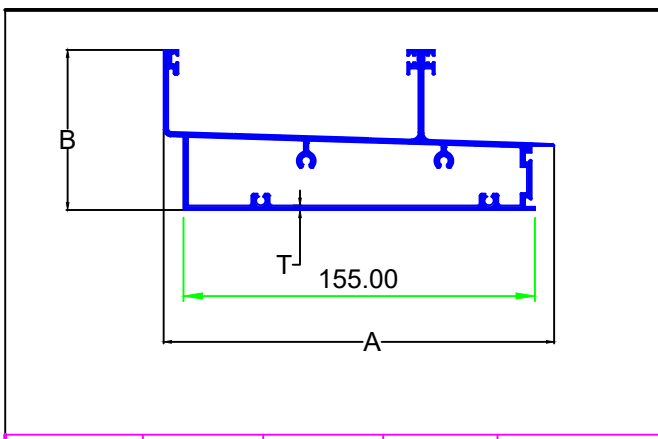

SEC.NO.	A	B	T	WT.Kg/mtr.
3799	172.17	70.63	2.00	3.102

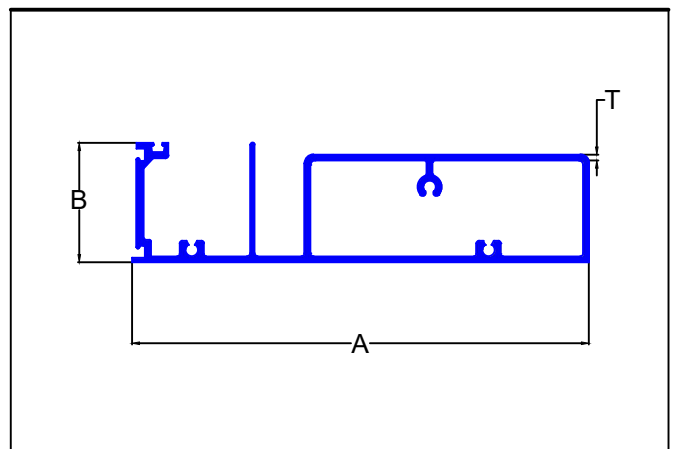

SEC.NO.	A	B	T	WT.Kg/mtr.
5500	155.00	40.50	2.00	2.444

UNITIZED GLAZING

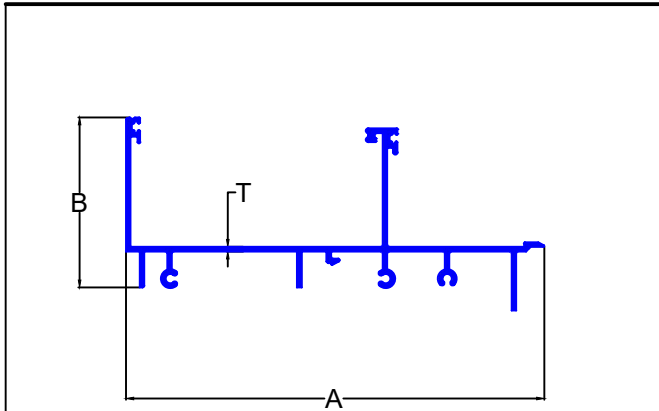

SEC.NO.	A	B	T	WT.Kg/mtr.
5501	184.38	75.00	2.00	2.563

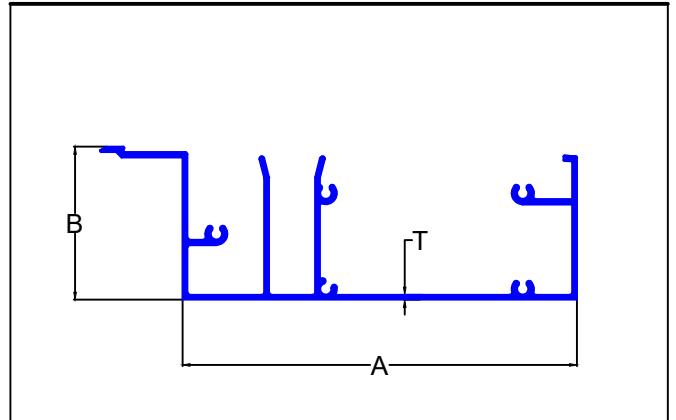

SEC.NO.	A	B	T	WT.Kg/mtr.
5502	144.98	56.19	1.80	3.066

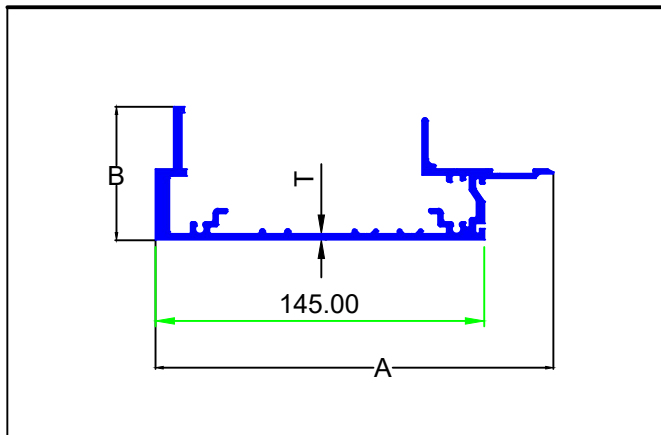

SEC.NO.	A	B	T	WT.Kg/mtr.
5503	175.40	58.50	2.50	2.969

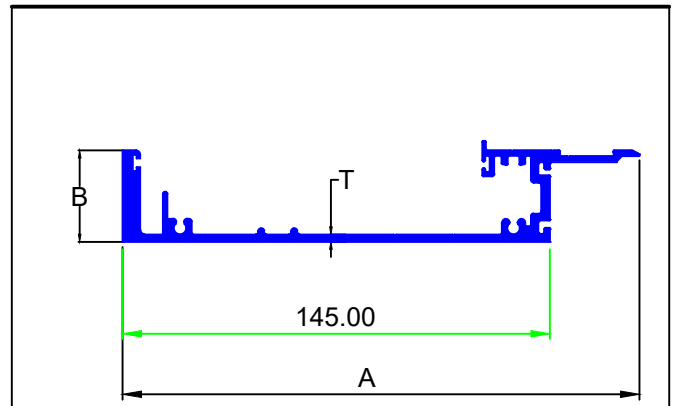

SEC.NO.	A	B	T	WT.Kg/mtr.
5504	175.4	31.00	2.50	2.321

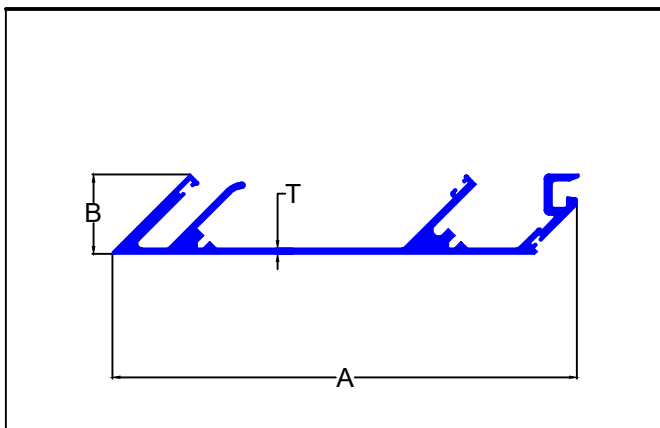

SEC.NO.	A	B	T	WT.Kg/mtr.
5505	205.50	35.00	2.50	3.318

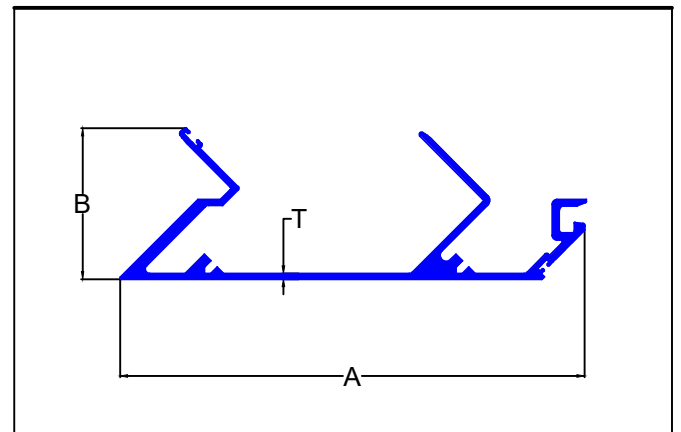

SEC.NO.	A	B	T	WT.Kg/mtr.
5506	205.50	66.48	2.50	3.702

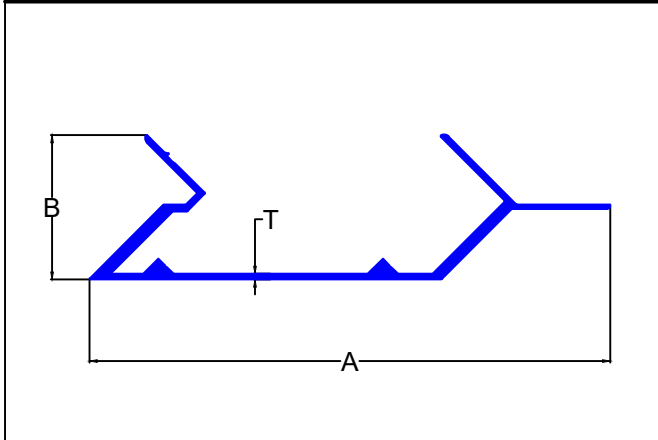

SEC.NO.	A	B	T	WT.Kg/mtr.
5507	229.57	63.65	2.50	3.256

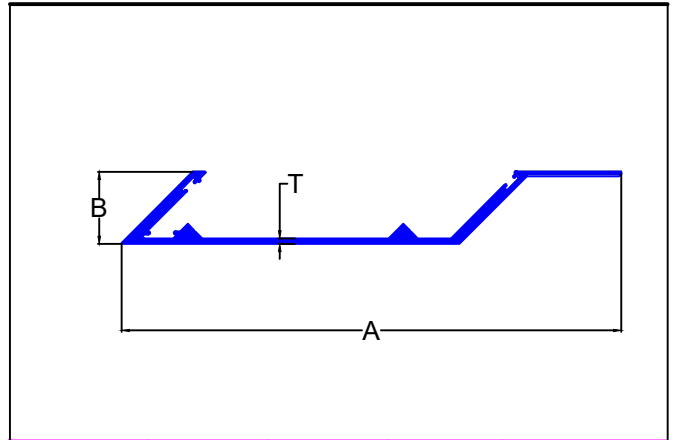

SEC.NO.	A	B	T	WT.Kg/mtr.
5508	229.52	33.00	2.50	2.500

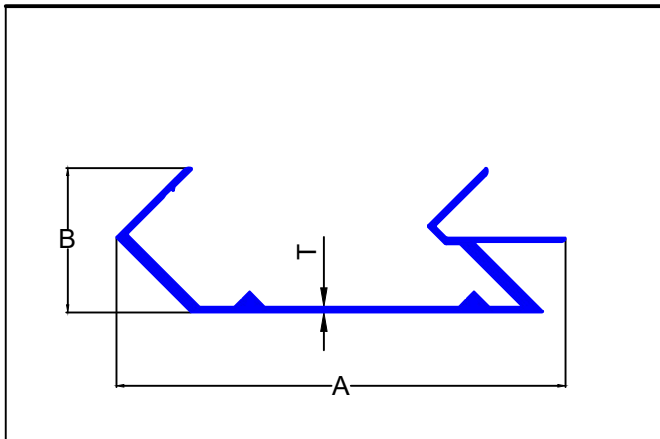

SEC.NO.	A	B	T	WT.Kg/mtr.
5509	197.99	63.82	2.50	3.252

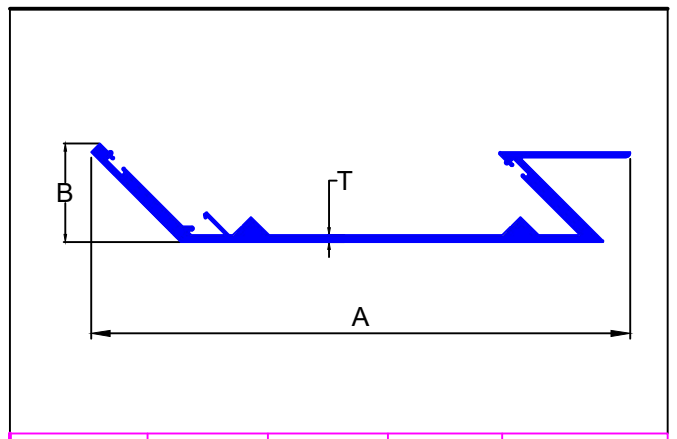

SEC.NO.	A	B	T	WT.Kg/mtr.
5510	198.06	36.18	2.50	2.553

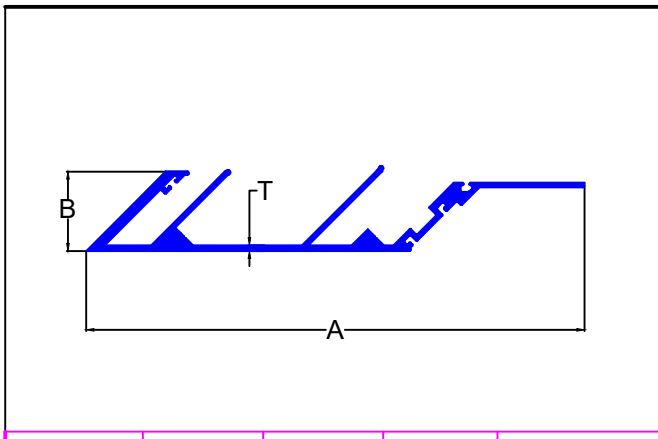

SEC.NO.	A	B	T	WT.Kg/mtr.
5511	219.66	35.00	2.50	3.081

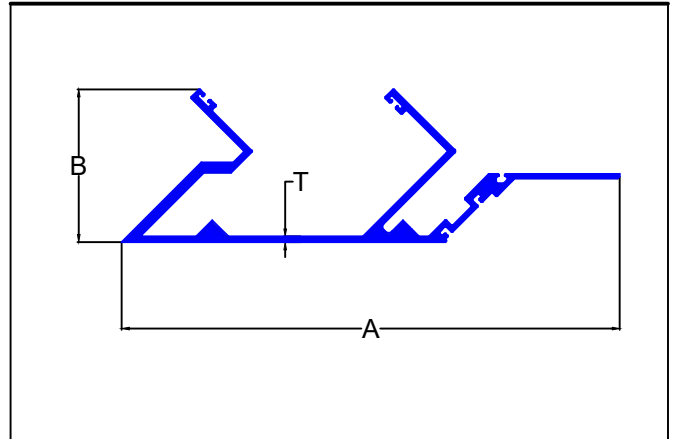

SEC.NO.	A	B	T	WT.Kg/mtr.
5512	219.66	67.36	2.50	3.652

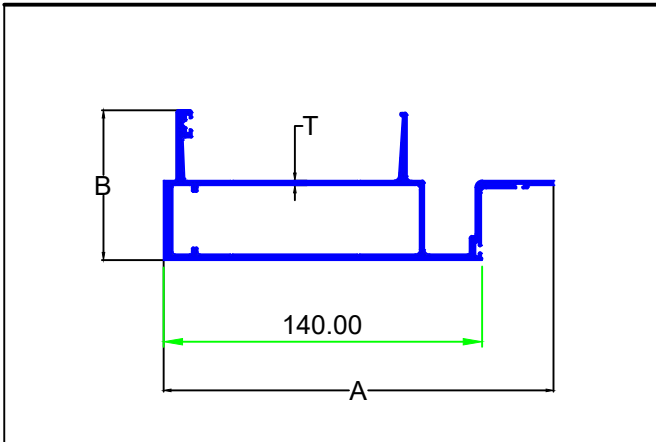

SEC.NO.	A	B	T	WT.Kg/mtr.
5513	172.00	66.00	2.00	3.131

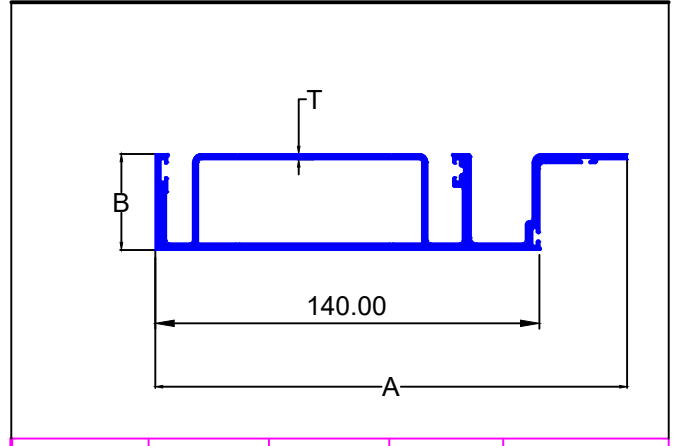

SEC.NO.	A	B	T	WT.Kg/mtr.
5514	172.00	35.00	2.00	2.848

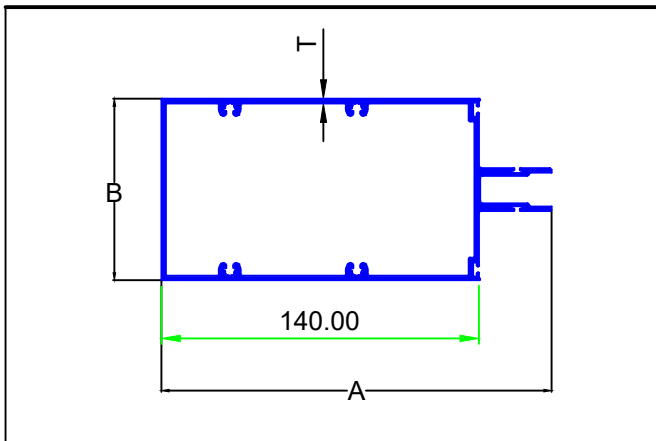

SEC.NO.	A	B	T	WT.Kg/mtr.
5515	172.00	80.00	2.00	3.177

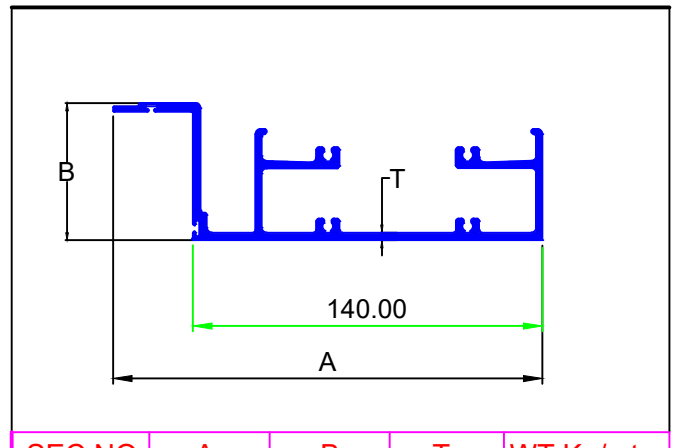

SEC.NO.	A	B	T	WT.Kg/mtr.
5516	172.00	53.51	2.50	3.223

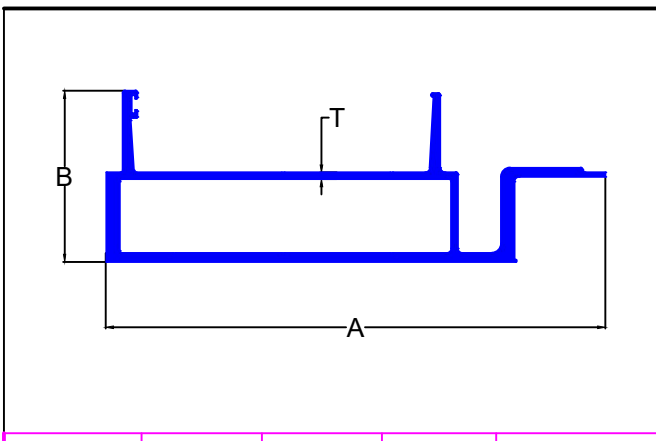

SEC.NO.	A	B	T	WT.Kg/mtr.
5517	220.00	75.50	3.00	5.796

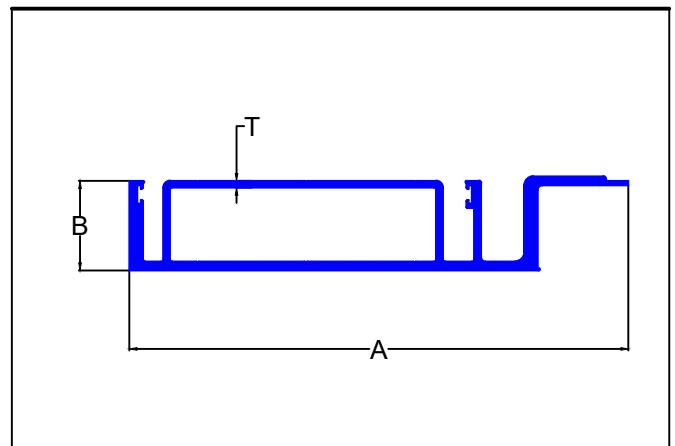

SEC.NO.	A	B	T	WT.Kg/mtr.
5518	220.00	39.50	3.00	5.339

UNITIZED GLAZING

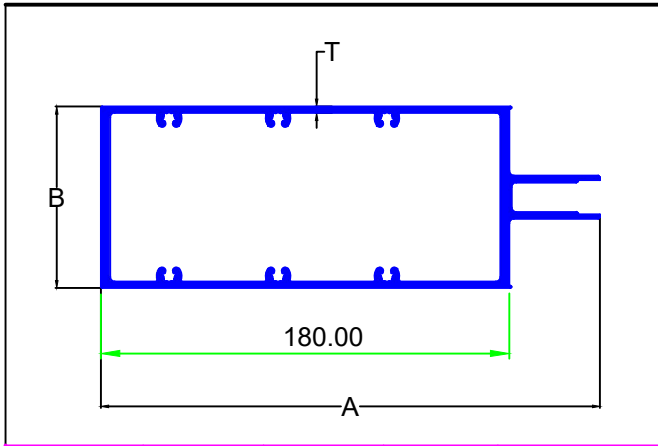

SEC.NO.	A	B	T	WT.Kg/mtr.
5519	220.00	80.00	2.80	5.570

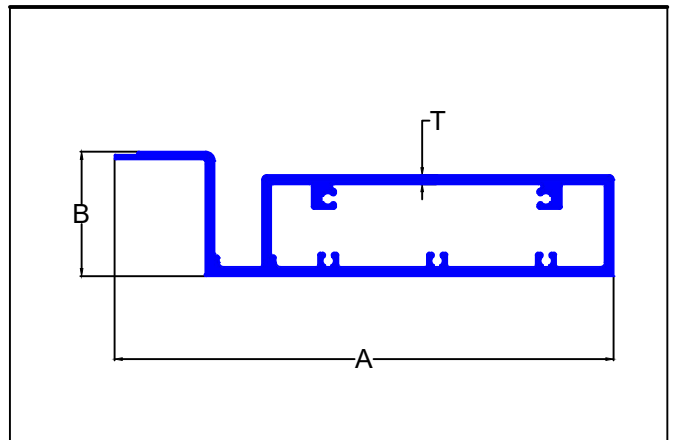

SEC.NO.	A	B	T	WT.Kg/mtr.
5520	220.00	54.80	4.00	6.060

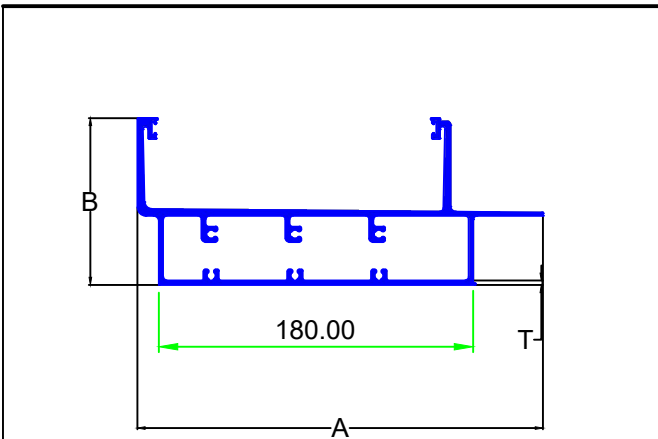

SEC.NO.	A	B	T	WT.Kg/mtr.
5521	232.15	95.50	2.50	5.720

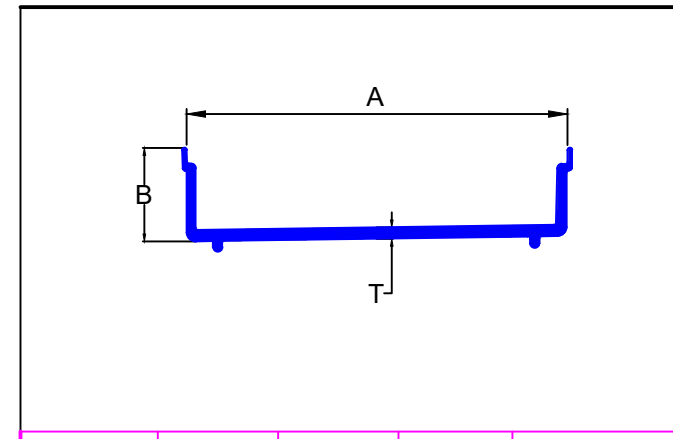

SEC.NO.	A	B	T	WT.Kg/mtr.
5522	167.92	41.29	4.96	3.055

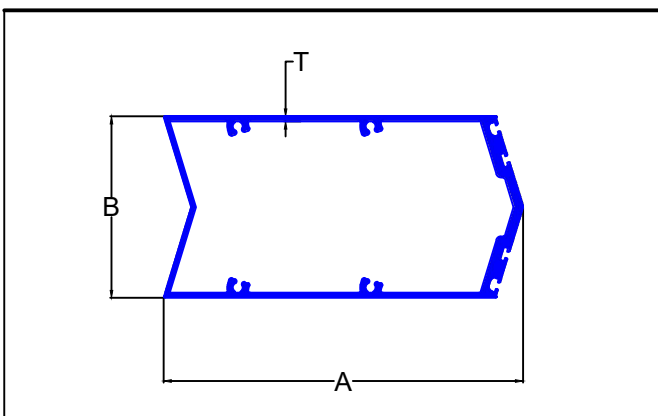

SEC.NO.	A	B	T	WT.Kg/mtr.
5523	158.45	80.00	2.25	3.629

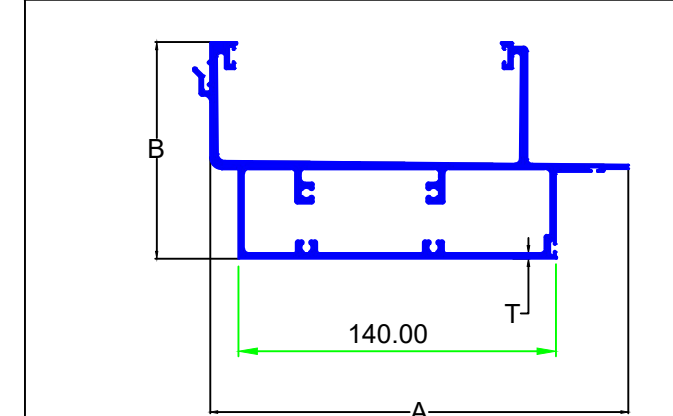

SEC.NO.	A	B	T	WT.Kg/mtr.
5524	184.45	95.50	2.50	4.838

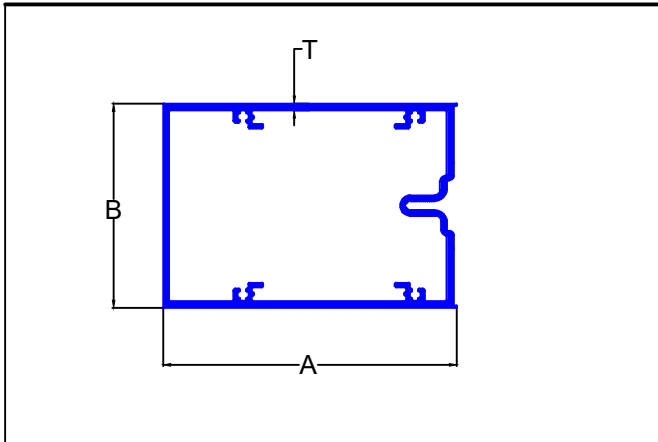

SEC.NO.	A	B	T	WT.Kg/mtr.
5525	129.50	90.00	3.00	3.939

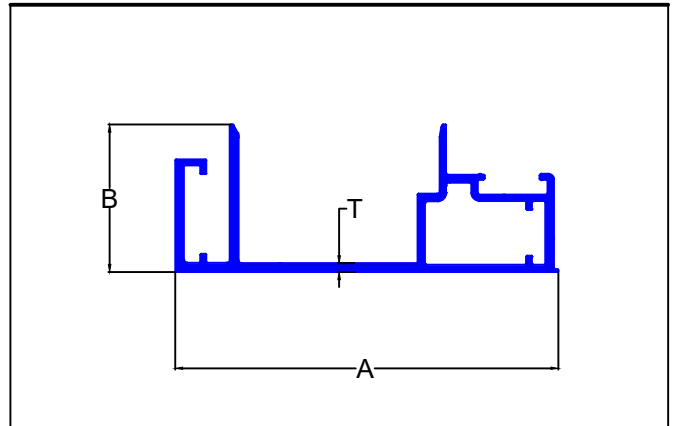

SEC.NO.	A	B	T	WT.Kg/mtr.
5526	130.00	50.00	3.00	2.606

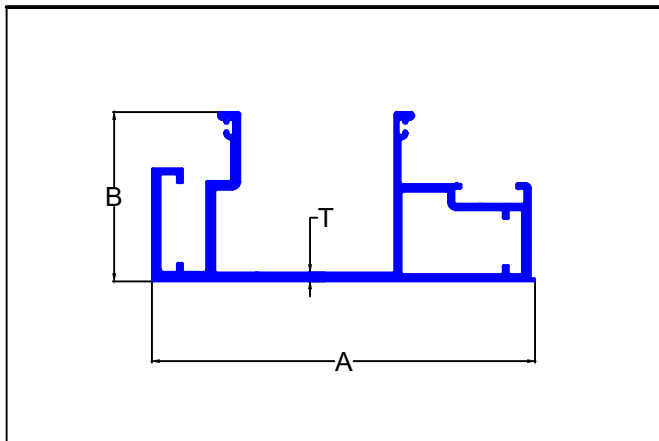

SEC.NO.	A	B	T	WT.Kg/mtr.
5527	130.00	57.40	3.00	2.885

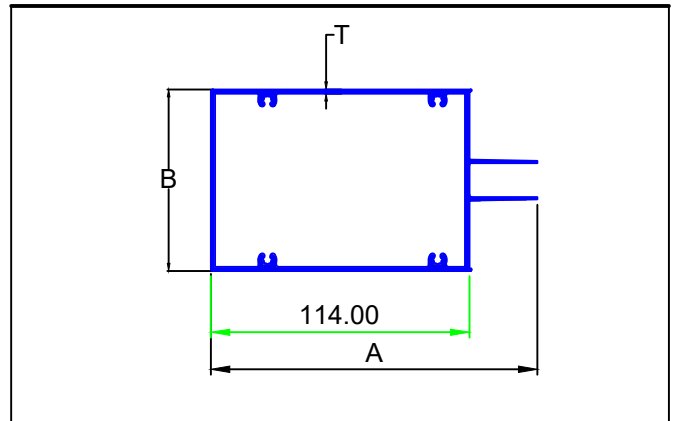

SEC.NO.	A	B	T	WT.Kg/mtr.
5528	144.00	80.00	1.80	2.418

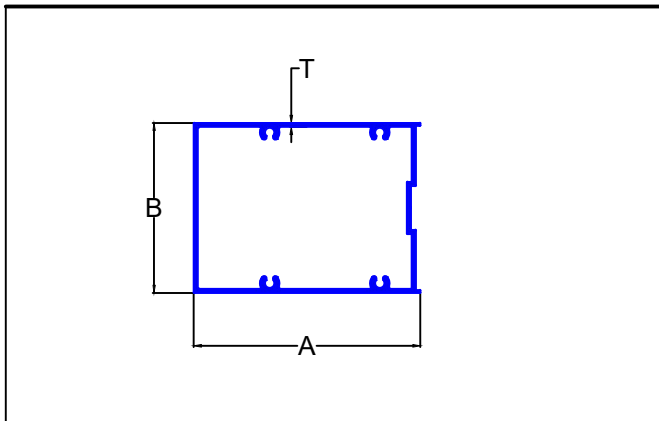

SEC.NO.	A	B	T	WT.Kg/mtr.
5529	100.00	75.00	1.80	1.975

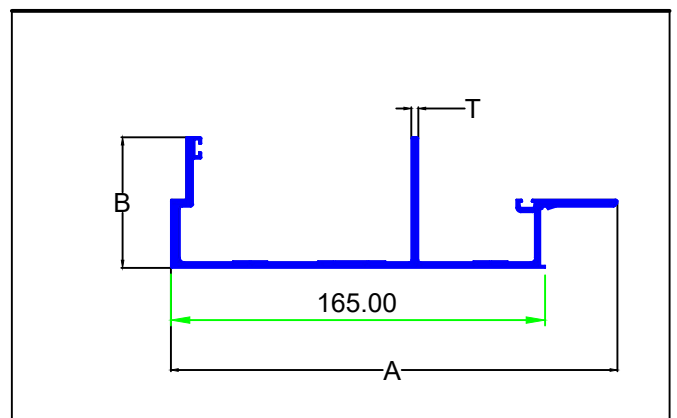

SEC.NO.	A	B	T	WT.Kg/mtr.
5530	197.00	57.50	3.02	2.766

UNITIZED GLAZING

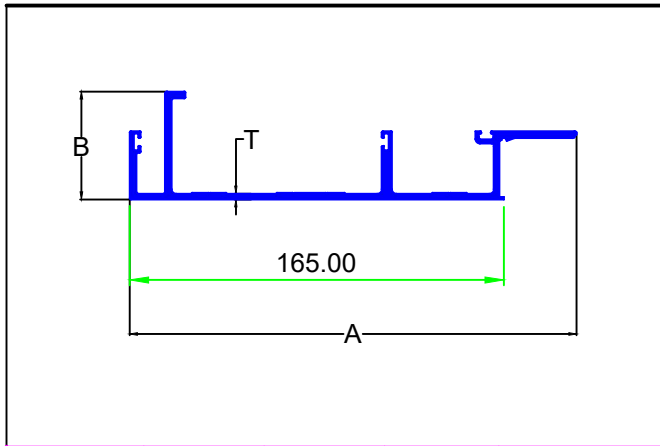

SEC.NO.	A	B	T	WT.Kg/mtr.
5531	197.00	47.50	2.50	2.626

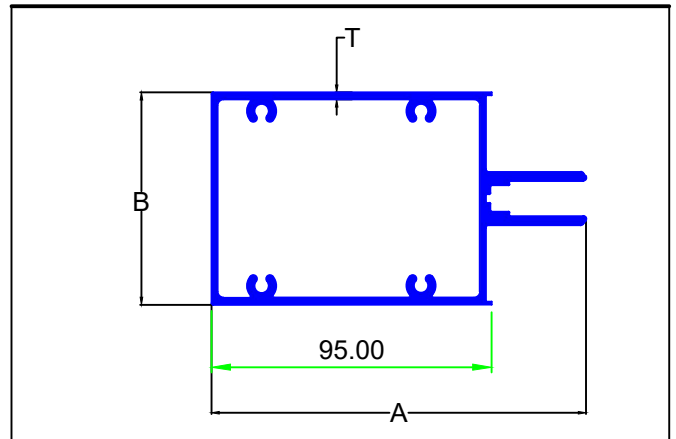

SEC.NO.	A	B	T	WT.Kg/mtr.
5532	127.00	72.00	2.00	3.056

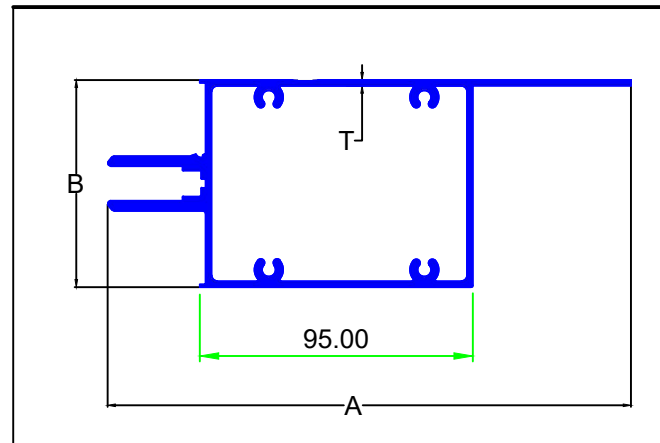

SEC.NO.	A	B	T	WT.Kg/mtr.
5533	150.00	72.00	2.00	3.161

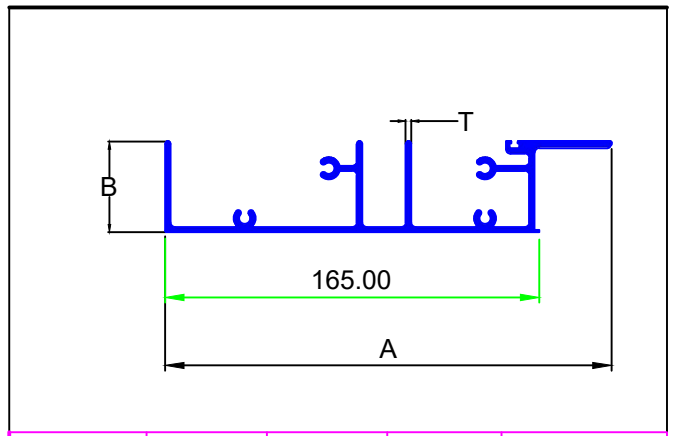

SEC.NO.	A	B	T	WT.Kg/mtr.
5534	197.00	40.00	2.50	3.016

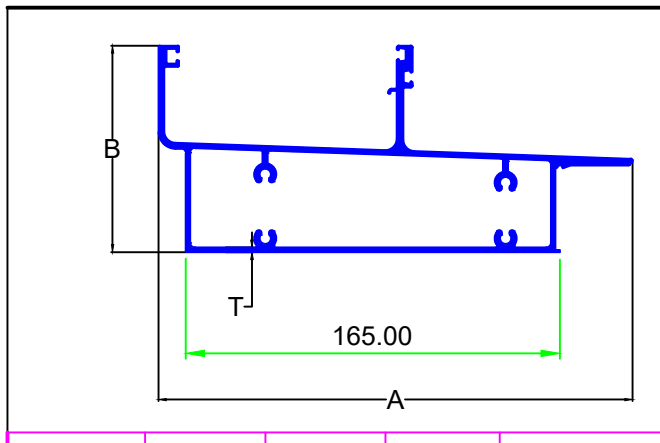

SEC.NO.	A	B	T	WT.Kg/mtr.
5535	208.95	91.00	2.00	4.056

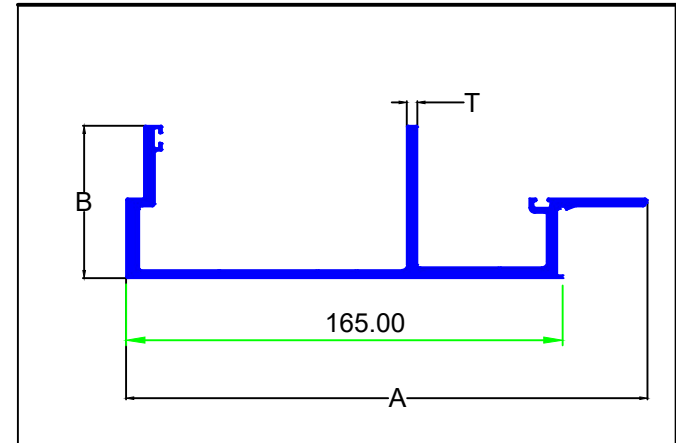

SEC.NO.	A	B	T	WT.Kg/mtr.
5536	197.00	57.50	4.00	3.392

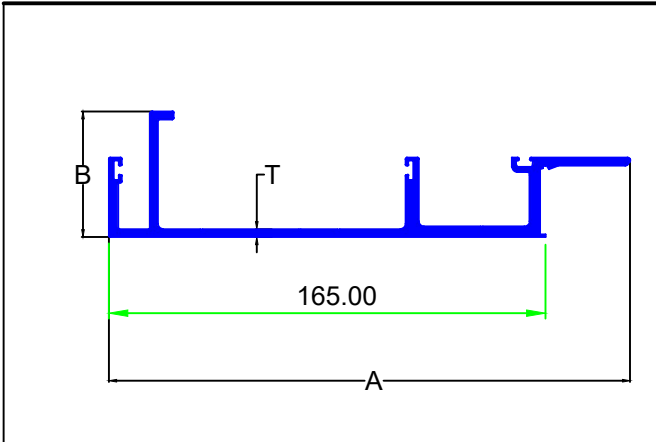

SEC.NO.	A	B	T	WT.Kg/mtr.
5537	197.00	47.50	3.00	3.023

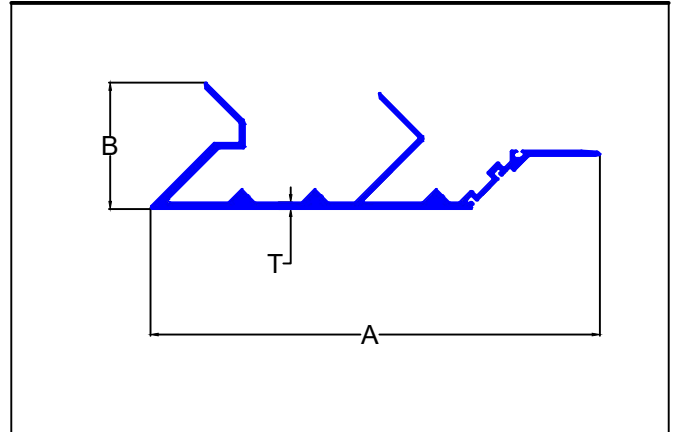

SEC.NO.	A	B	T	WT.Kg/mtr.
5538	237.77	66.78	3.50	4.065

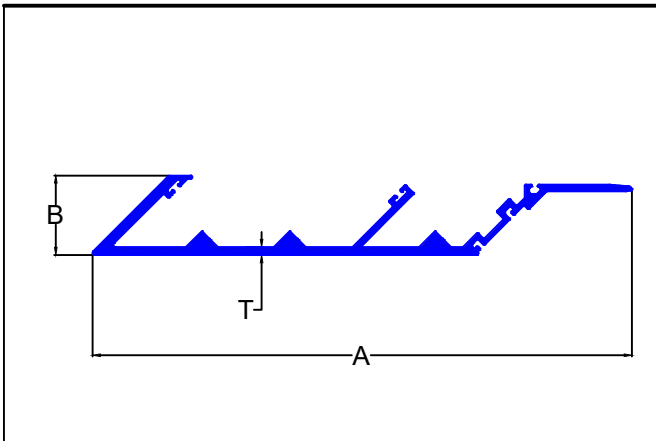

SEC.NO.	A	B	T	WT.Kg/mtr.
5539	237.77	35.00	3.50	3.538

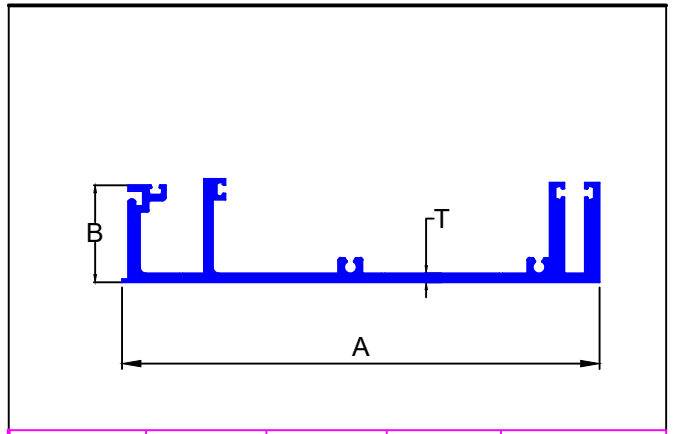

SEC.NO.	A	B	T	WT.Kg/mtr.
5540	162.00	35.00	3.00	2.897

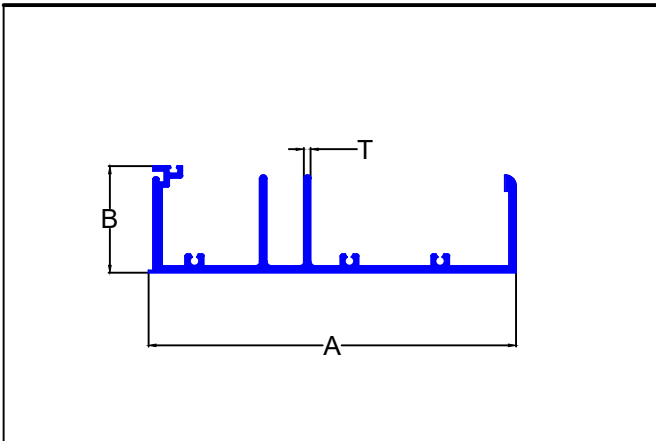

SEC.NO.	A	B	T	WT.Kg/mtr.
5542	162.00	47.00	3.00	3.041

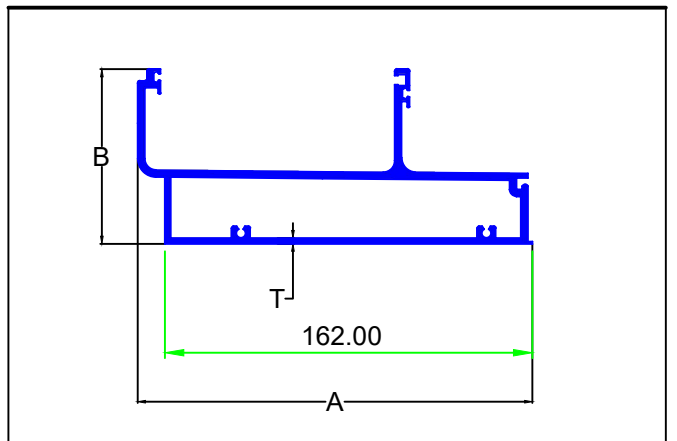

SEC.NO.	A	B	T	WT.Kg/mtr.
5543	173.94	77.00	2.50	3.910

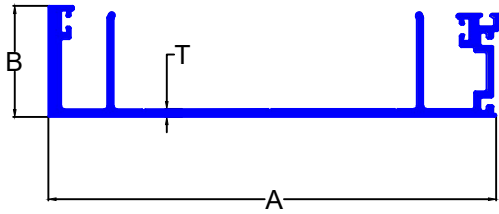

SEC.NO.	A	B	T	WT.Kg/mtr.
5544	140.00	35.00	2.50	4.065

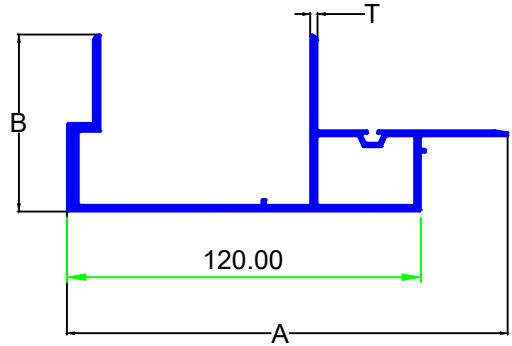

SEC.NO.	A	B	T	WT.Kg/mtr.
5545	149.50	60.00	2.20	2.176

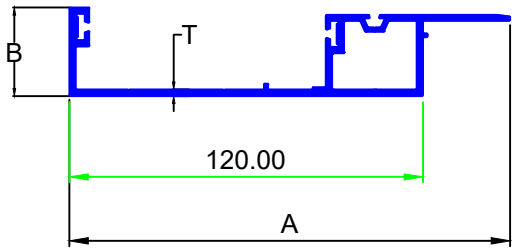

SEC.NO.	A	B	T	WT.Kg/mtr.
5546	149.50	30.00	2.20	1.677

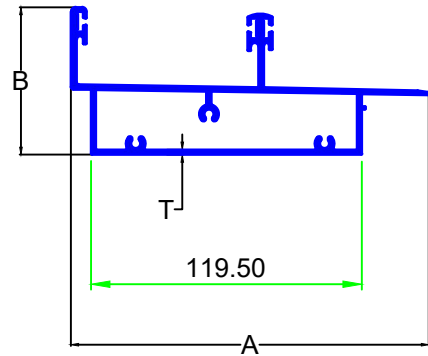

SEC.NO.	A	B	T	WT.Kg/mtr.
5547	157.80	65.00	2.20	2.899

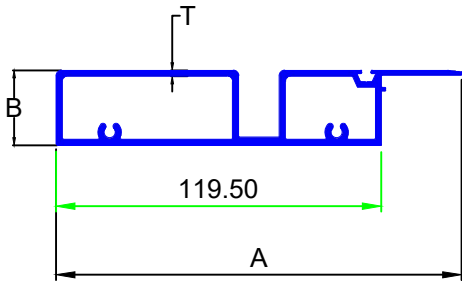

SEC.NO.	A	B	T	WT.Kg/mtr.
5548	149.00	27.50	2.20	2.231

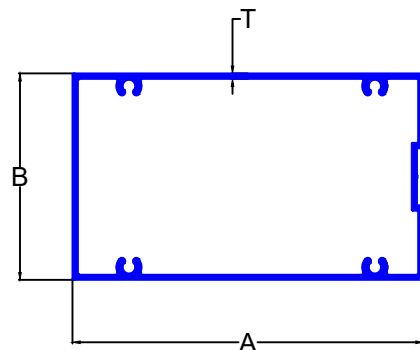

SEC.NO.	A	B	T	WT.Kg/mtr.
5549	119.00	70.00	1.80	2.126

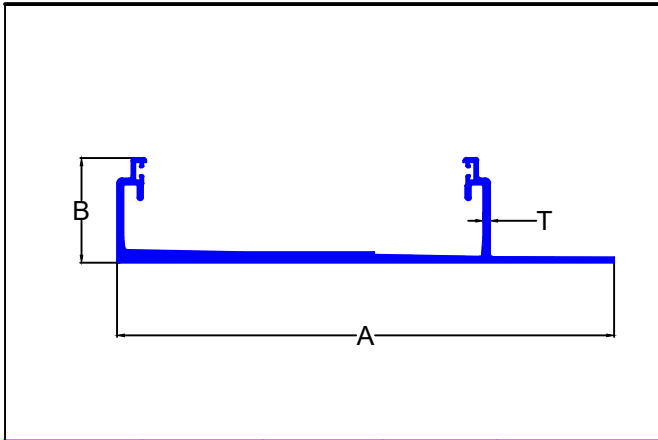

SEC.NO.	A	B	T	WT.Kg/mtr.
5550	187.96	39.55	2.50	2.336

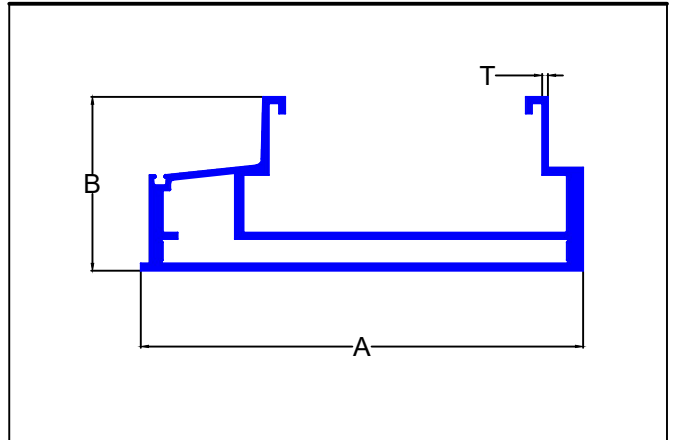

SEC.NO.	A	B	T	WT.Kg/mtr.
5551	150.00	59.00	2.00	3.357

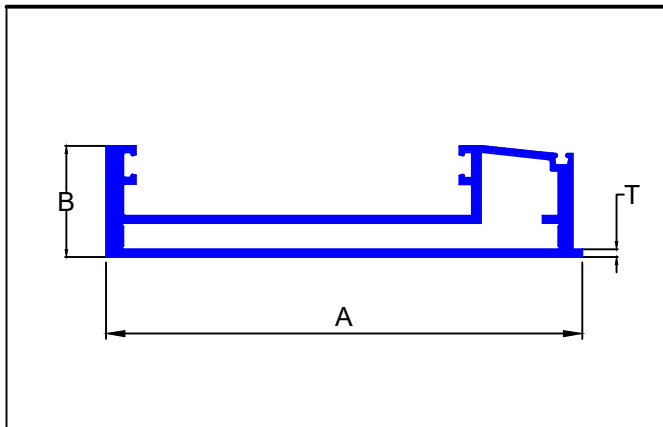

SEC.NO.	A	B	T	WT.Kg/mtr.
5552	150.00	35.00	2.50	2.943

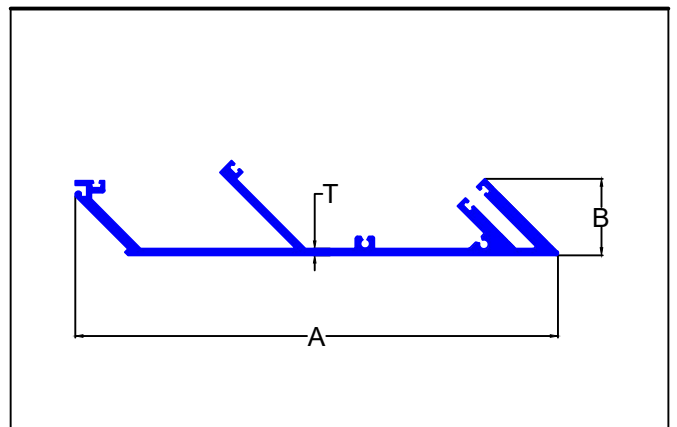

SEC.NO.	A	B	T	WT.Kg/mtr.
5553	212.80	33.75	3.00	3.484

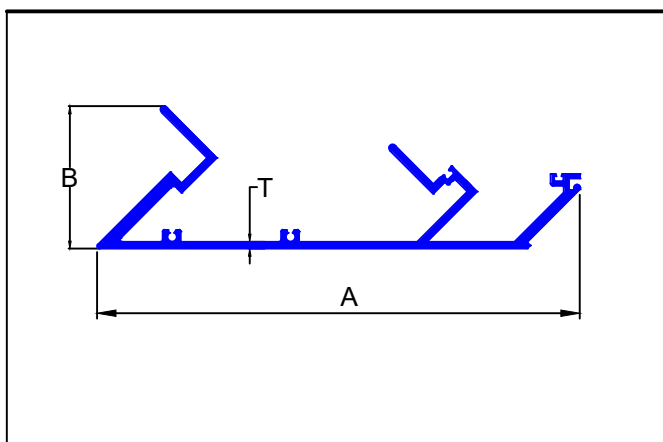

SEC.NO.	A	B	T	WT.Kg/mtr.
5554	212.80	62.78	3.00	3.790

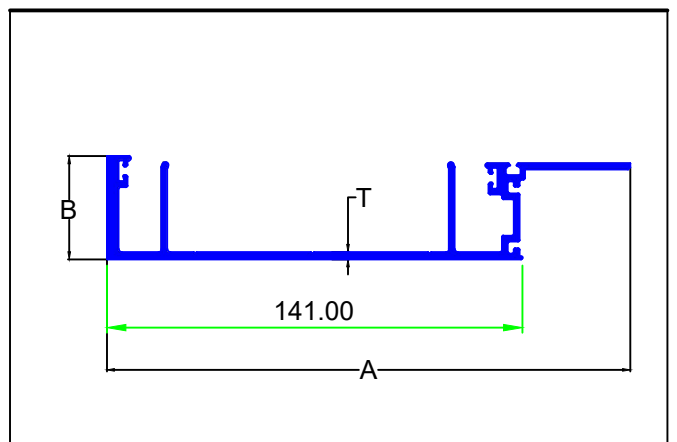

SEC.NO.	A	B	T	WT.Kg/mtr.
5555	177.52	35.00	2.50	2.215

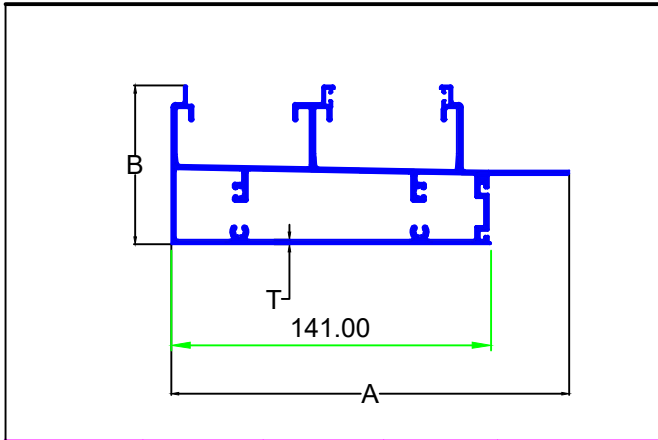

SEC.NO.	A	B	T	WT.Kg/mtr.
5556	175.52	70.00	2.00	3.614

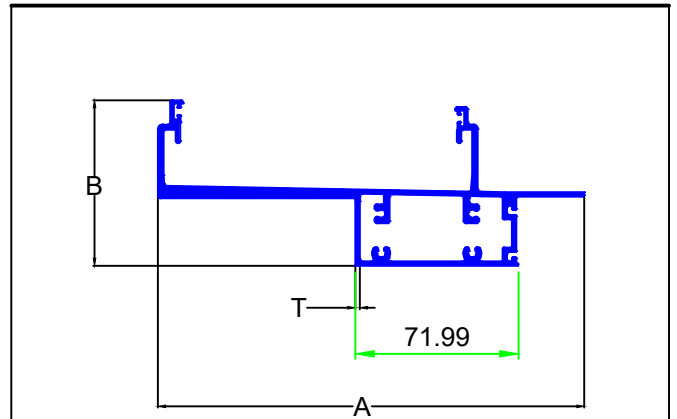

SEC.NO.	A	B	T	WT.Kg/mtr.
5557	188.02	73.00	2.00	3.587

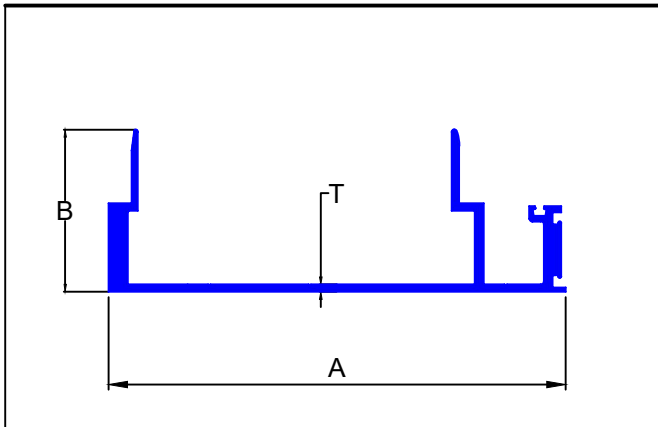

SEC.NO.	A	B	T	WT.Kg/mtr.
5558	155.00	55.00	2.50	2.509

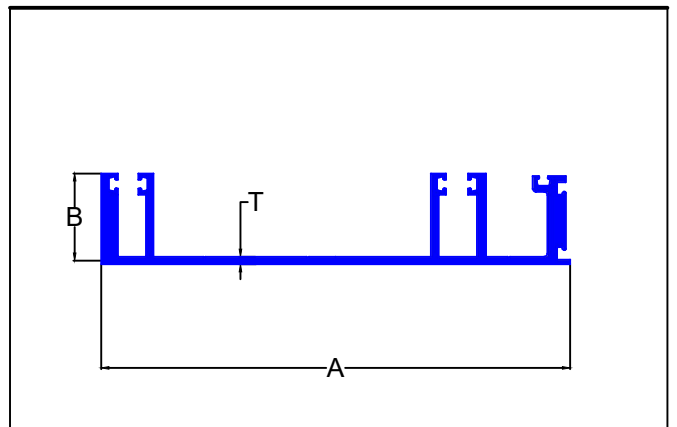

SEC.NO.	A	B	T	WT.Kg/mtr.
5559	155.00	30.00	2.50	2.471

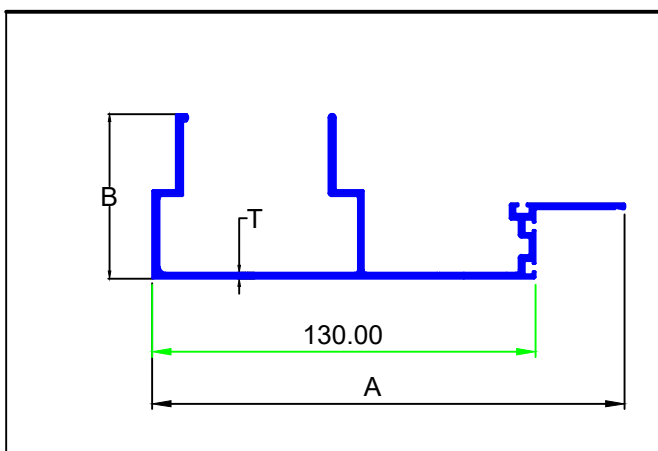

SEC.NO.	A	B	T	WT.Kg/mtr.
5560	160.50	55.80	2.50	1.891

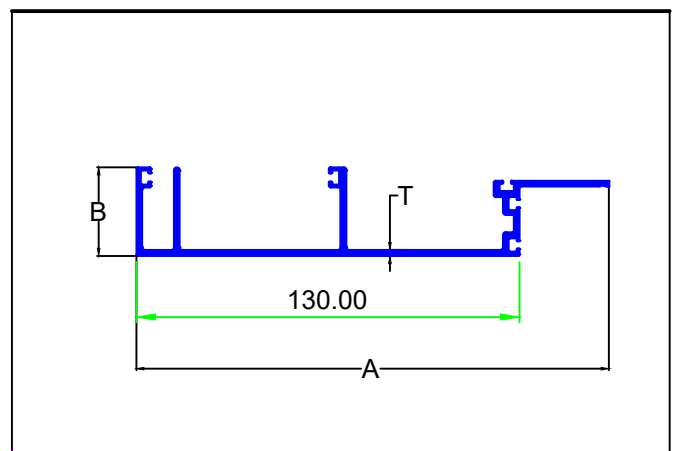

SEC.NO.	A	B	T	WT.Kg/mtr.
5561	160.50	30.01	2.00	1.596

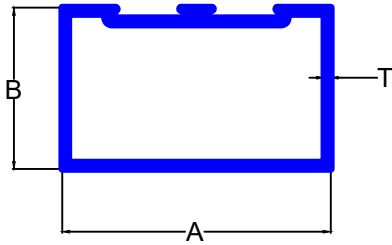

SEC.NO.	A	B	T	WT.Kg/mtr.
3101	63.50	38.10	0.95	0.576
3111	101.60	44.45	2.60	2.053
3112	101.60	44.45	3.00	2.352
3113	101.00	44.00	1.23	0.580
3114	100.00	44.00	1.23	0.440
3115	63.00	38.00	1.93	1.079
5900	63.00	38.00	1.15	0.671
5901	63.00	38.00	1.40	0.803
5902	63.00	38.00	0.96	0.569
5903	89.00	32.00	2.75	1.790
5904	63.50	38.00	3.00	1.621

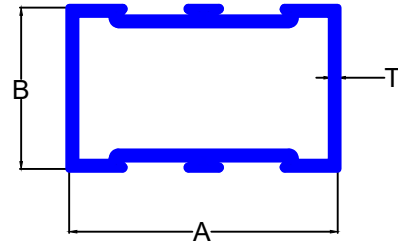

SEC.NO.	A	B	T	WT.Kg/mtr.
3117	63.50	38.10	0.85	0.585
3127	101.60	44.45	2.25	1.850
3129	101.60	44.45	2.60	2.128
3130	101.60	44.45	3.00	2.437
3131	135.00	40.00	1.50	1.528
5931	100.00	44.00	1.10	0.971
5932	102.60	44.00	1.20	1.069
5933	100.00	44.00	3.00	2.449
5934	63.00	38.00	1.08	0.675
5935	63.00	38.00	1.80	1.077
5936	63.00	38.00	1.30	0.811
5937	63.00	38.00	0.96	0.626
5938	89.00	32.00	2.75	1.870
5939	63.50	38.00	3.00	1.697

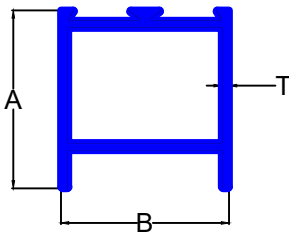

SEC.NO.	A	B	T	WT.Kg/mtr.
3134	47.50	44.45	1.20	0.638
3137	114.30	44.45	2.80	2.352
3138	149.50	44.45	3.00	3.183
3139	47.00	44.00	1.60	0.783
3140	47.00	44.00	0.83	0.447
5952	95.00	44.40	3.00	2.185

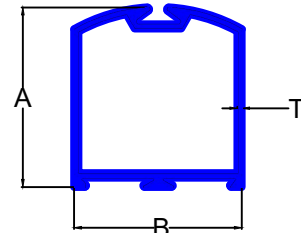

SEC.NO.	A	B	T	WT.Kg/mtr.
3142	47.50	44.45	1.10	0.630
3143	47.50	44.45	1.20	0.673
3146	85.00	44.45	3.00	2.048
3147	47.00	44.00	1.98	1.017
3148	47.00	44.00	0.79	0.448
3149	47.00	44.00	1.57	0.838

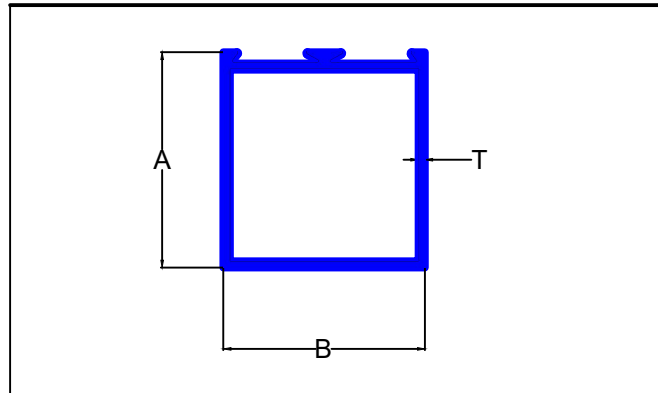

SEC.NO.	A	B	T	WT.Kg/mtr.
3152	47.50	44.45	1.20	0.633
3153	47.00	44.00	1.10	0.580

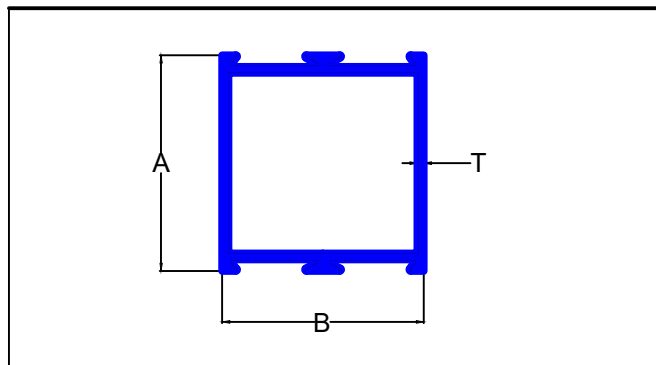

SEC.NO.	A	B	T	WT.Kg/mtr.
3162	47.50	44.45	1.20	0.687
3163	47.50	44.45	1.45	0.796
3164	47.00	44.00	0.93	0.580

18.0X62.0 MM SLIDING WINDOW

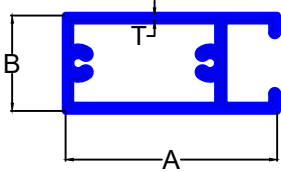

SEC.NO.	A	B	T	WT.Kg/mtr.
2902	40.00	18.00	1.00	0.358
2905	40.00	18.00	2.00	0.690
2906	40.00	18.00	1.30	0.451

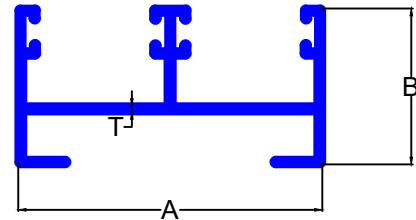

SEC.NO.	A	B	T	WT.Kg/mtr.
2934	61.85	31.75	1.20	0.632
2936	61.85	31.75	1.40	0.725
2938	62.81	32.00	1.00	0.580

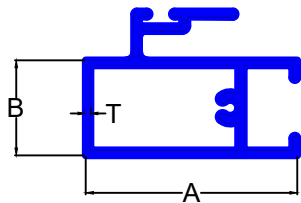

SEC.NO.	A	B	T	WT.Kg/mtr.
2914	40.00	18.00	1.20	0.499
2916	40.00	18.00	2.00	0.810
2917	40.00	18.00	0.88	0.385
2918	40.00	18.00	1.30	0.546

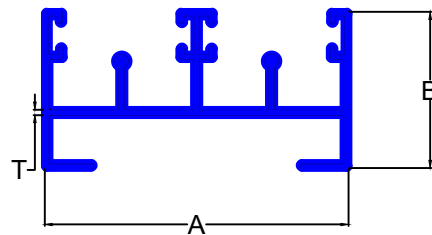

SEC.NO.	A	B	T	WT.Kg/mtr.
2944	61.85	31.75	1.20	0.713
2947	61.85	31.75	1.50	0.876
2948	62.80	32.40	0.91	0.567
2949	61.80	32.10	1.24	0.727

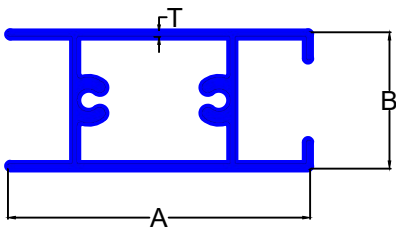

SEC.NO.	A	B	T	WT.Kg/mtr.
2925	40.00	18.00	1.20	0.410
2927	40.00	18.00	2.00	0.690
2928	40.44	18.20	0.98	0.357
2929	40.00	18.00	1.30	0.451

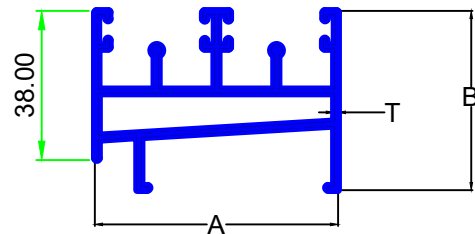

SEC.NO.	A	B	T	WT.Kg/mtr.
2951	62.00	46.00	1.30	1.044
2952	113.00	41.00	1.40	1.700

18.0X92.0 MM SLIDING WINDOW

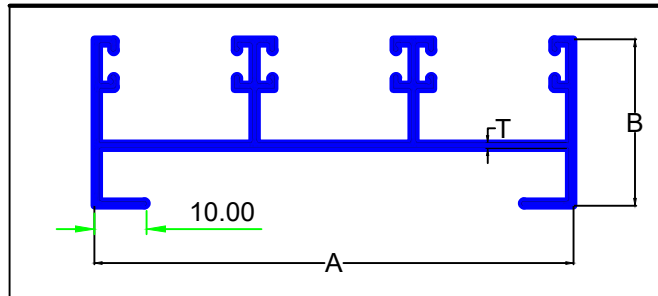

SEC.NO.	A	B	T	WT.Kg/mtr.
2962	92.00	31.75	1.55	1.101
2964	92.00	31.75	2.00	1.270

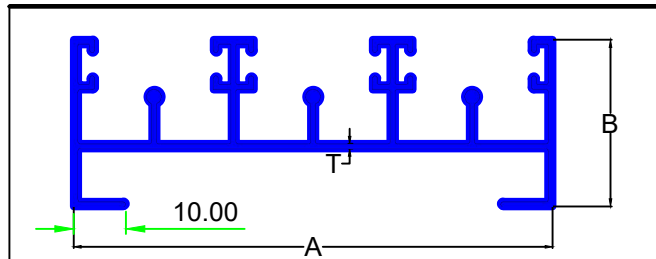

SEC.NO.	A	B	T	WT.Kg/mtr.
2973	92.00	31.75	1.40	1.102
2974	92.00	31.50	1.25	0.993
2975	92.00	31.55	0.98	0.800
2976	92.00	31.75	2.00	1.480

SLIDING WINDOW

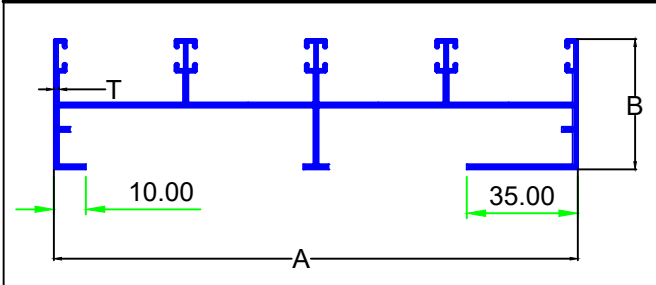

SEC.NO.	A	B	T	WT.Kg/mtr.
2987	165.00	41.00	1.60	1.824

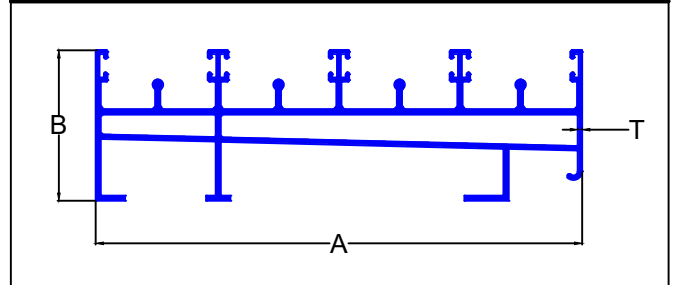

SEC.NO.	A	B	T	WT.Kg/mtr.
2988	165.00	51.00	1.50	2.914

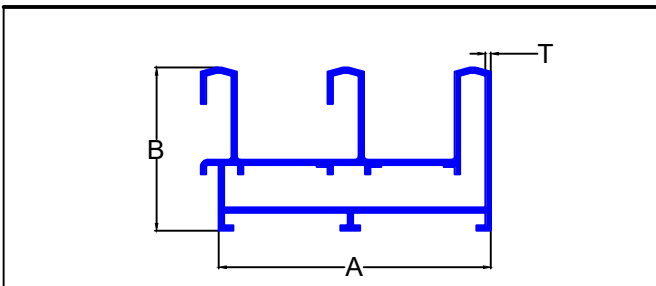

SEC.NO.	A	B	T	WT.Kg/mtr.
2989	75.00	45.00	1.50	1.397

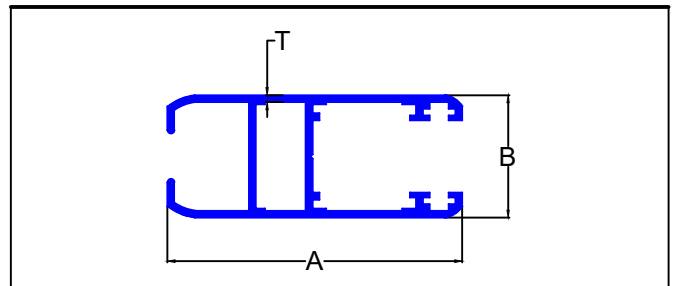

SEC.NO.	A	B	T	WT.Kg/mtr.
2990	65.00	27.00	1.50	0.889

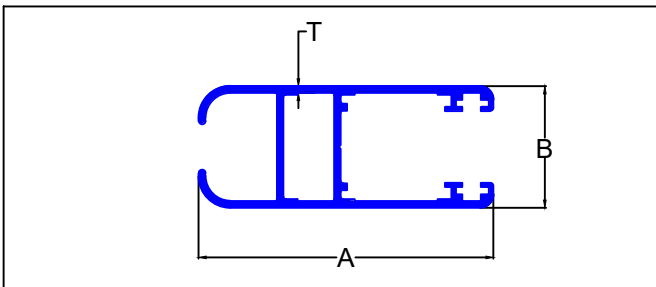

SEC.NO.	A	B	T	WT.Kg/mtr.
2991	65.00	26.80	1.50	0.840

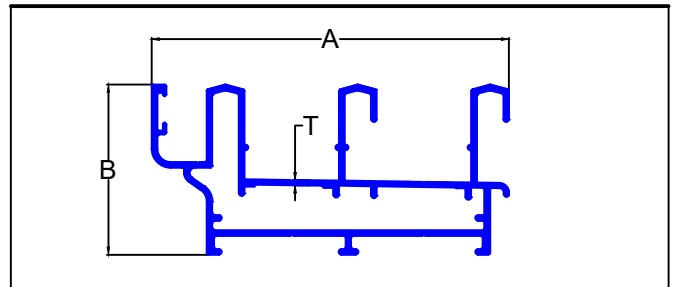

SEC.NO.	A	B	T	WT.Kg/mtr.
2992	94.50	45.00	1.40	1.595

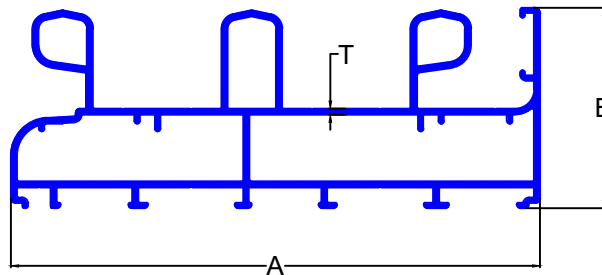

SEC.NO.	A	B	T	WT.Kg/mtr.
2993	140.00	53.00	1.60	2.668
3005	140.00	53.00	1.50	2.539

SLIDING WINDOW

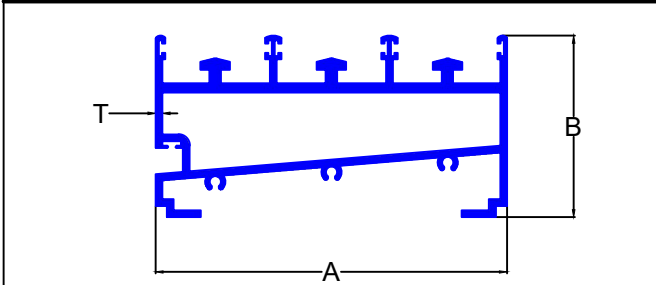

SEC.NO.	A	B	T	WT.Kg/mtr.
2994	155.00	80.00	3.00	5.771

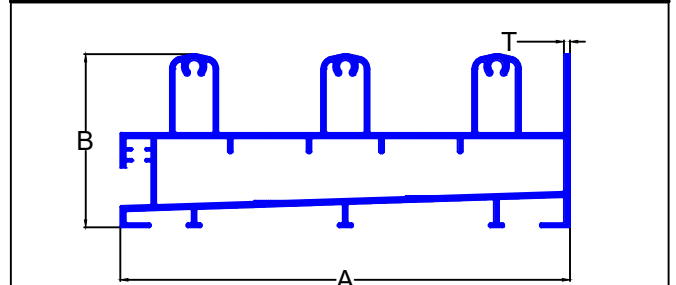

SEC.NO.	A	B	T	WT.Kg/mtr.
2995	148.70	57.30	2.00	3.179

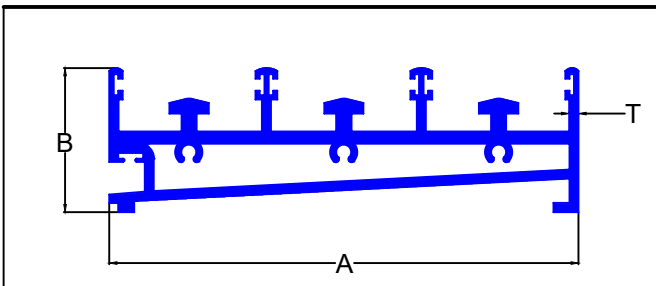

SEC.NO.	A	B	T	WT.Kg/mtr.
2996	155.20	47.61	3.10	5.060

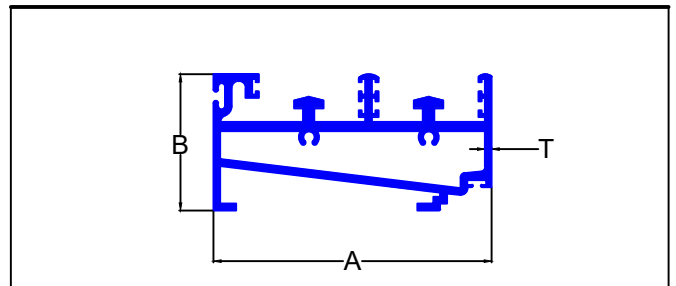

SEC.NO.	A	B	T	WT.Kg/mtr.
2997	122.70	60.00	3.00	4.632

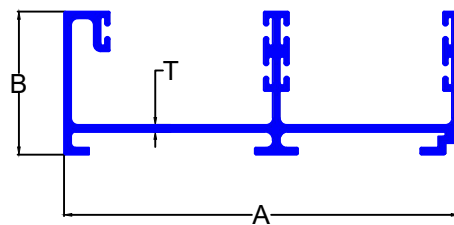

SEC.NO.	A	B	T	WT.Kg/mtr.
2998	174.00	63.00	3.00	4.130

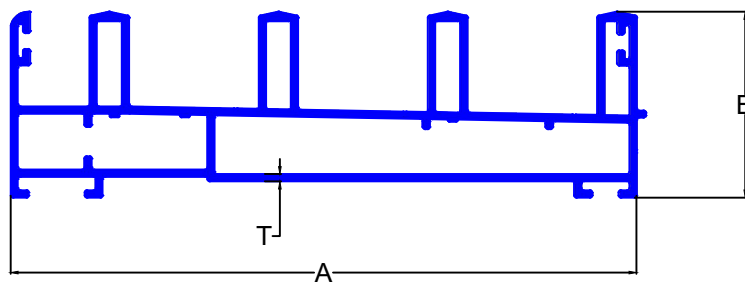

SEC.NO.	A	B	T	WT.Kg/mtr.
2999	138.00	41.00	1.60	2.531

SLIDING WINDOW

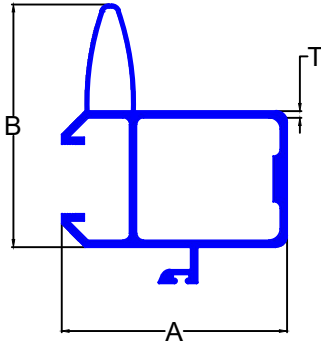

SEC.NO.	A	B	T	WT.Kg/mtr.
3000	99.40	107.00	3.00	3.563

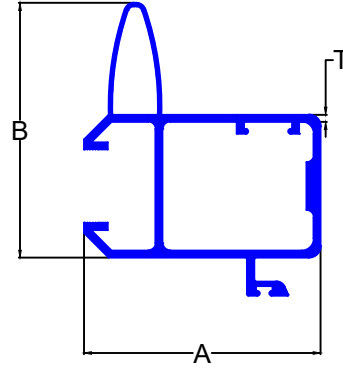

SEC.NO.	A	B	T	WT.Kg/mtr.
3001	99.40	107.00	3.00	3.659

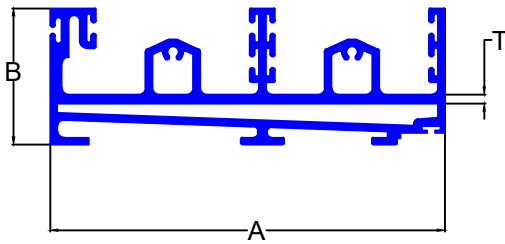

SEC.NO.	A	B	T	WT.Kg/mtr.
3002	174.00	60.00	4.00	7.123

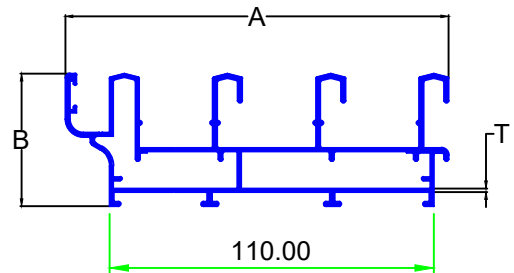

SEC.NO.	A	B	T	WT.Kg/mtr.
3003	130.00	45.00	1.20	1.909

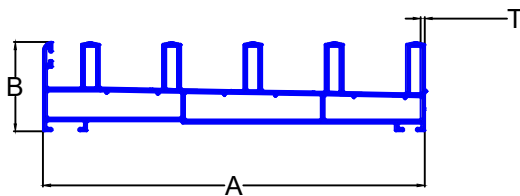

SEC.NO.	A	B	T	WT.Kg/mtr.
3004	175.30	41.00	1.80	3.366

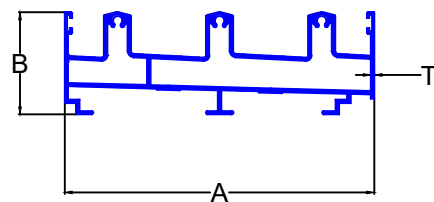

SEC.NO.	A	B	T	WT.Kg/mtr.
3006	136.50	45.00	1.50	2.281

SLIDING WINDOW

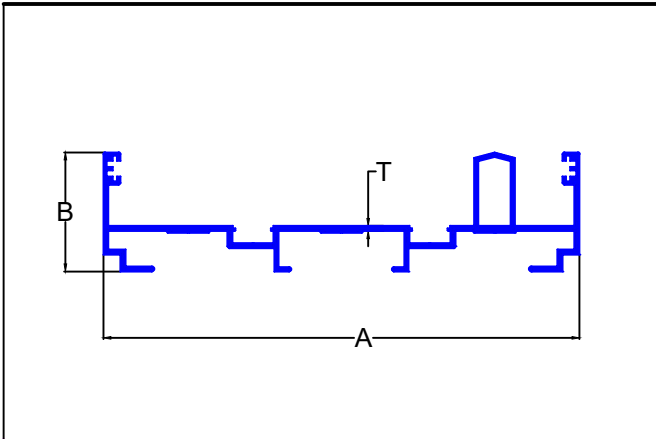

SEC.NO.	A	B	T	WT.Kg/mtr.
3007	140.00	35.00	1.50	1.392

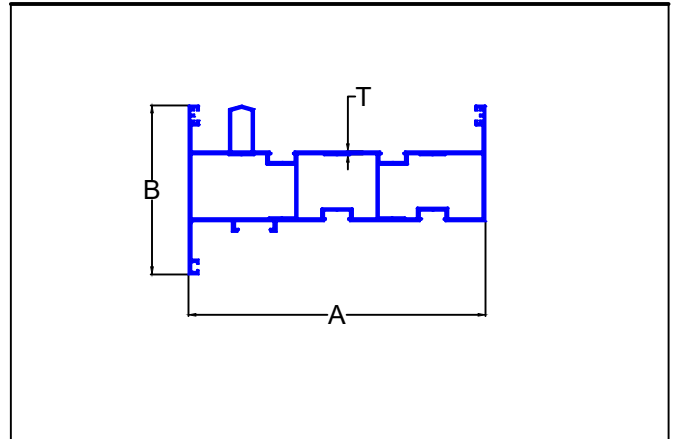

SEC.NO.	A	B	T	WT.Kg/mtr.
3008	140.00	79.61	1.50	2.387

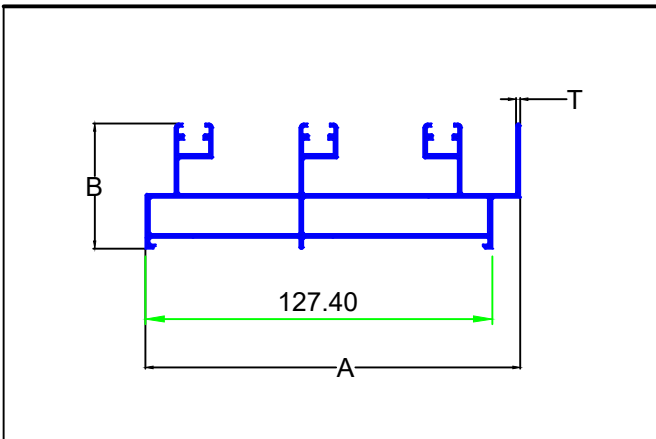

SEC.NO.	A	B	T	WT.Kg/mtr.
3009	137.70	46.00	1.60	1.999

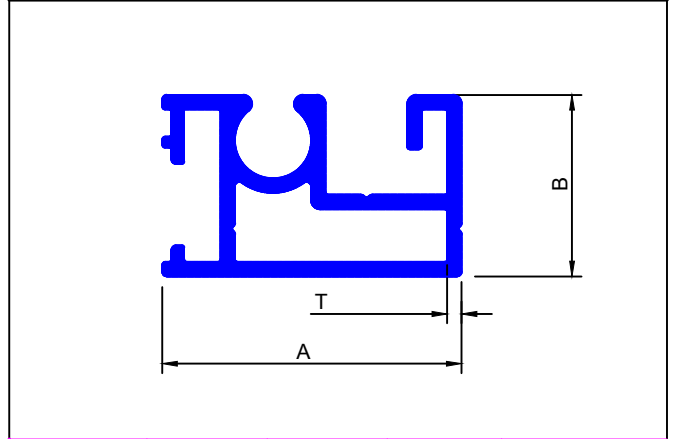

SEC.NO.	A	B	T	WT.Kg/mtr.
3010	33.00	20.00	1.60	0.578

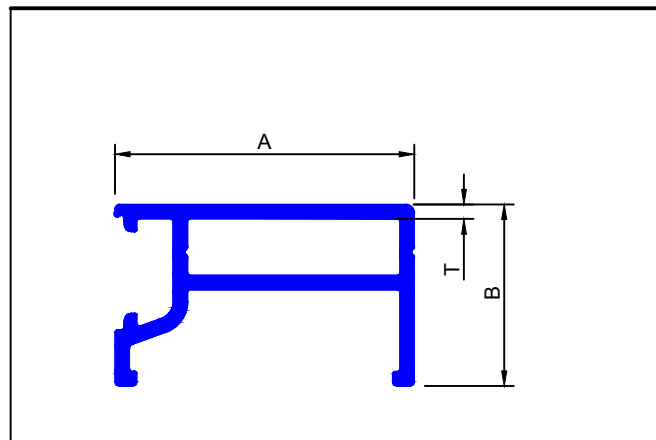

SEC.NO.	A	B	T	WT.Kg/mtr.
3011	33.00	20.00	1.60	0.436

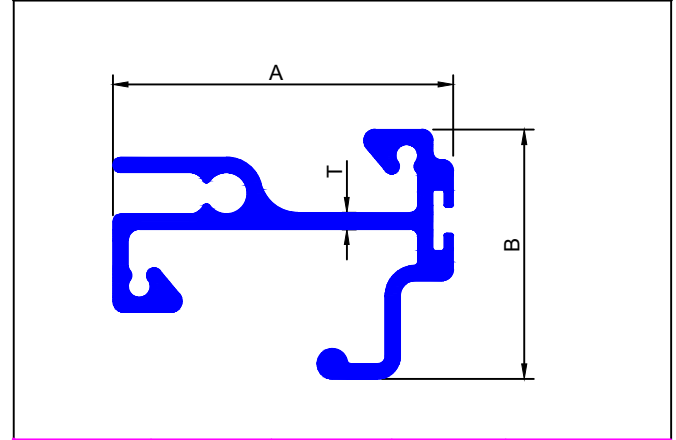

SEC.NO.	A	B	T	WT.Kg/mtr.
3012	45.00	33.00	2.20	0.907

SLIDING WINDOW

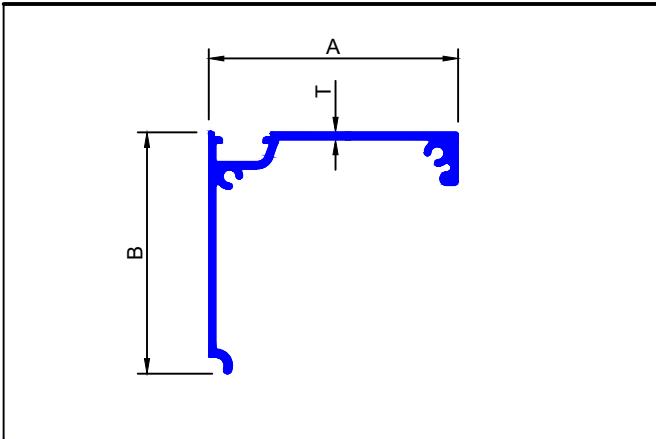

SEC.NO.	A	B	T	WT.Kg/mtr.
3013	55.00	53.20	1.60	0.651

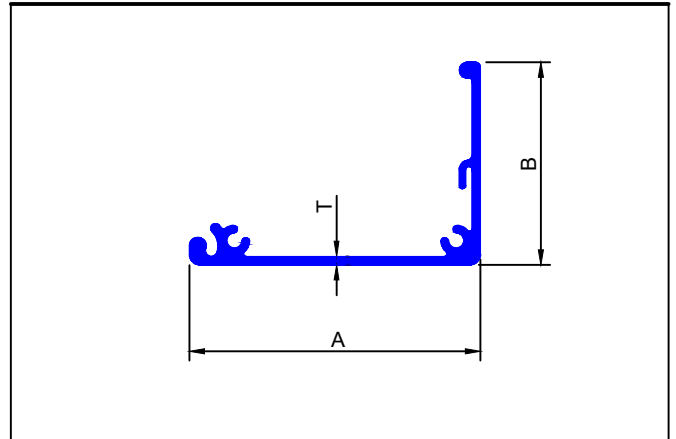

SEC.NO.	A	B	T	WT.Kg/mtr.
3014	55.00	38.30	1.60	0.572

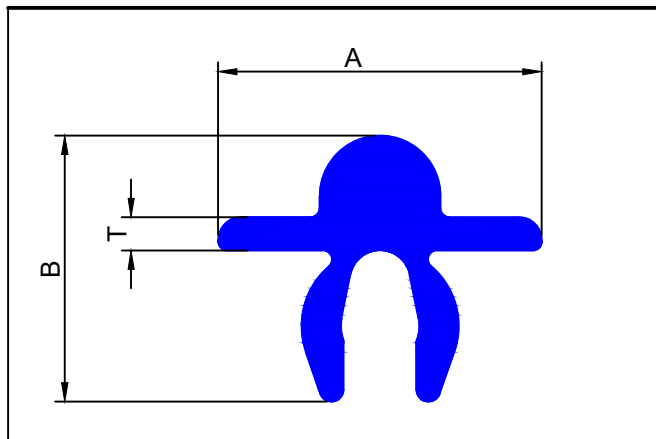

SEC.NO.	A	B	T	WT.Kg/mtr.
3015	10.70	8.80	1.10	0.085

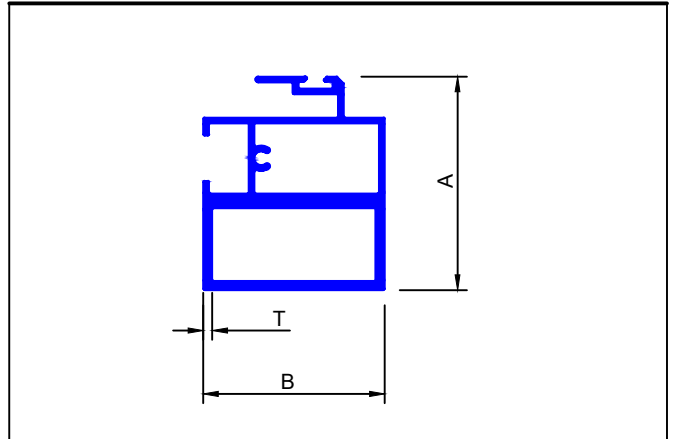

SEC.NO.	A	B	T	WT.Kg/mtr.
3016	47.02	40.00	2.01	1.155

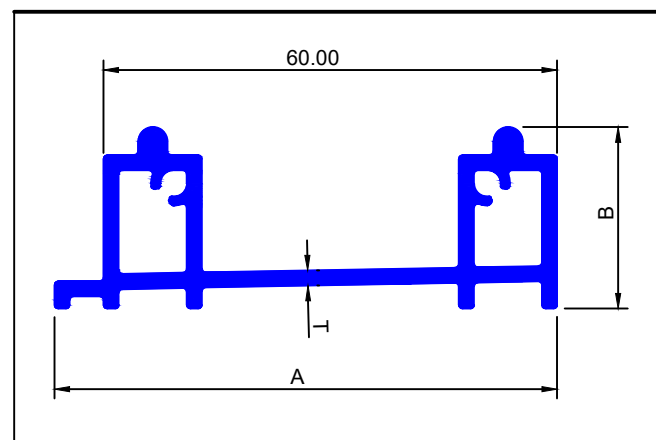

SEC.NO.	A	B	T	WT.Kg/mtr.
3017	66.31	24.00	2.00	0.966

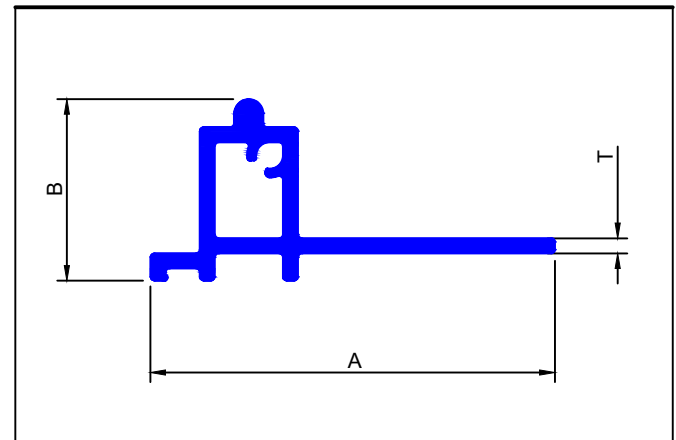

SEC.NO.	A	B	T	WT.Kg/mtr.
3018	53.50	24.00	2.00	0.596

SLIDING WINDOW

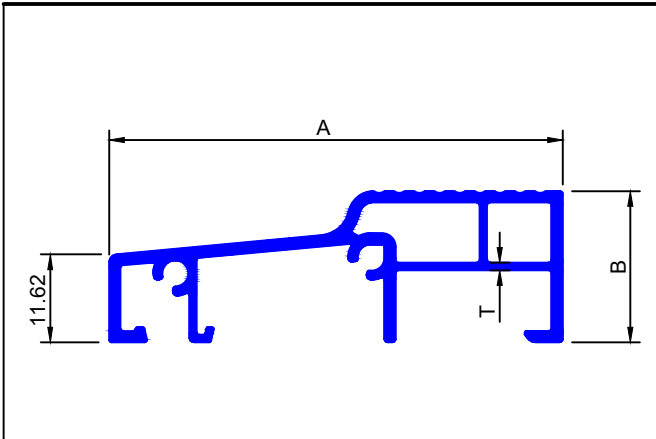

SEC.NO.	A	B	T	WT.Kg/mtr.
3019	60.00	20.00	1.00	0.623

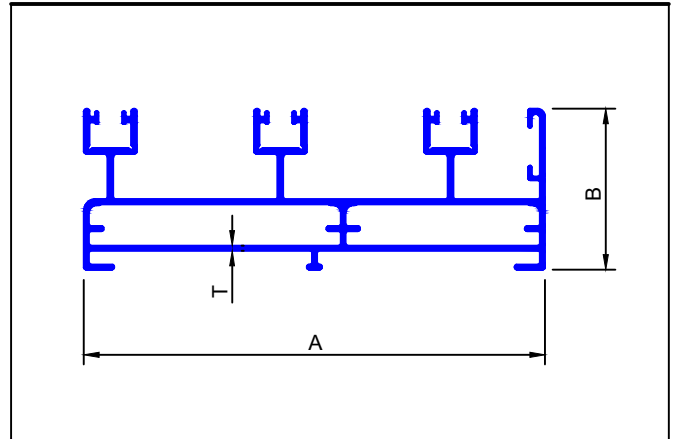

SEC.NO.	A	B	T	WT.Kg/mtr.
3020	122.00	42.60	1.35	1.968

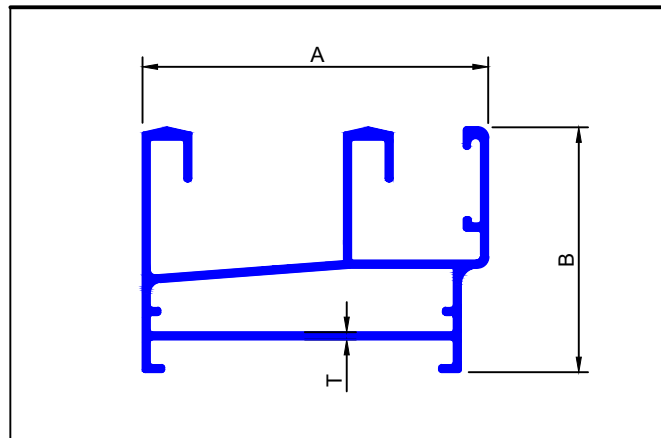

SEC.NO.	A	B	T	WT.Kg/mtr.
3021	63.50	45.01	1.35	1.046

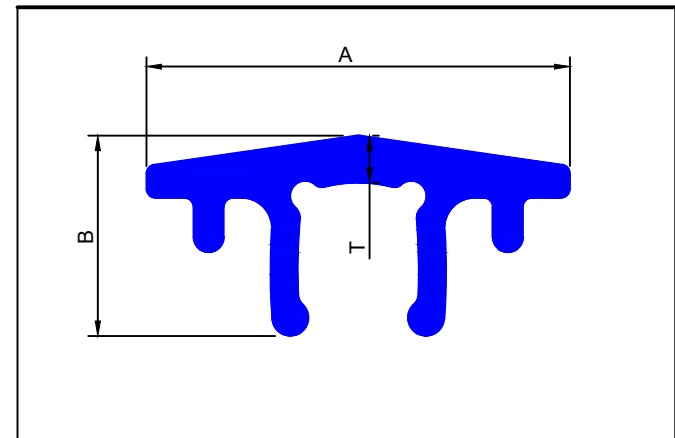

SEC.NO.	A	B	T	WT.Kg/mtr.
3022	14.00	6.63	1.56	0.086

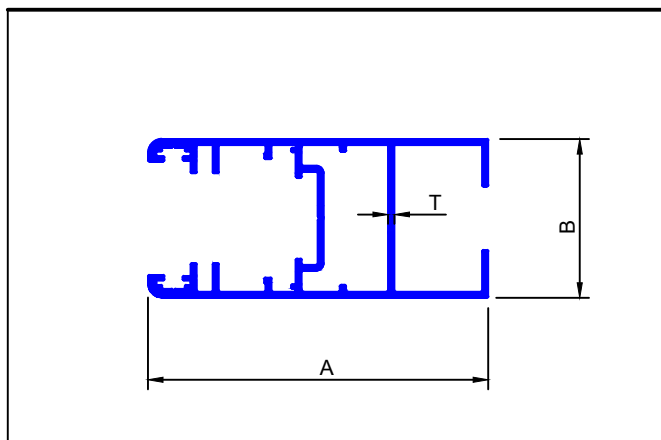

SEC.NO.	A	B	T	WT.Kg/mtr.
3023	75.00	35.00	1.35	1.107

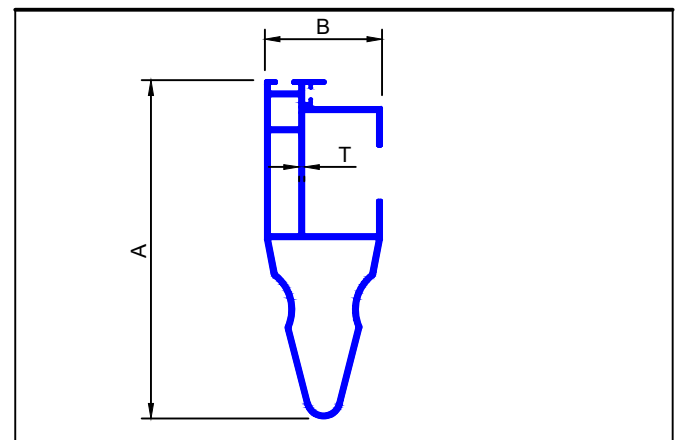

SEC.NO.	A	B	T	WT.Kg/mtr.
3024	89.50	31.00	1.35	1.021

SLIDING WINDOW

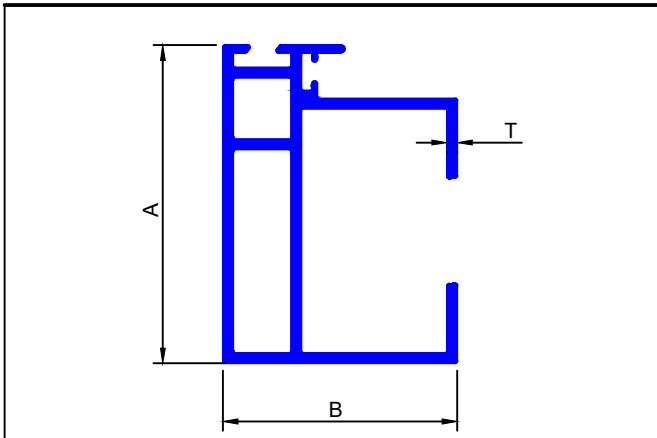

SEC.NO.	A	B	T	WT.Kg/mtr.
3025	42.06	31.00	1.35	0.644

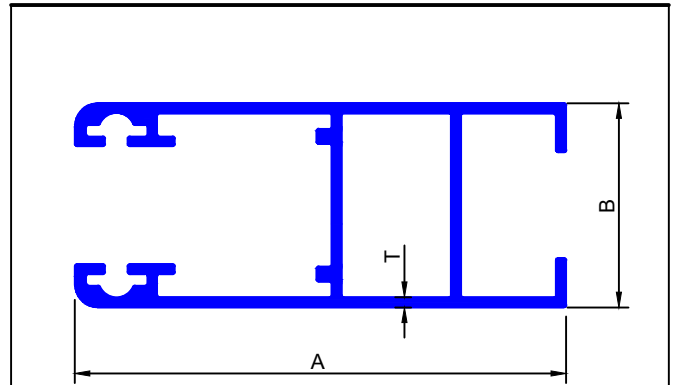

SEC.NO.	A	B	T	WT.Kg/mtr.
3026	65.00	27.00	1.35	0.856

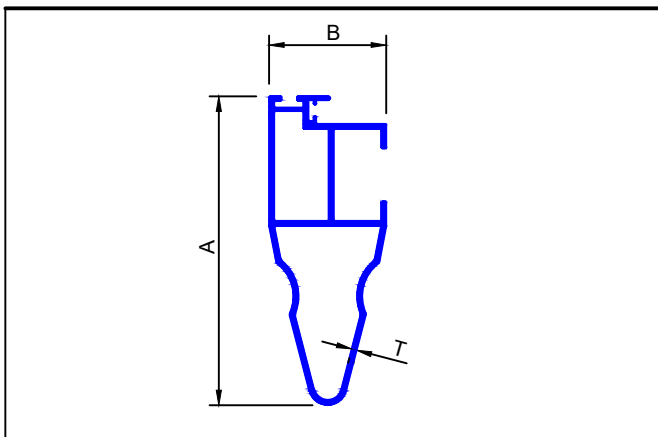

SEC.NO.	A	B	T	WT.Kg/mtr.
3027	81.70	31.00	1.35	0.898

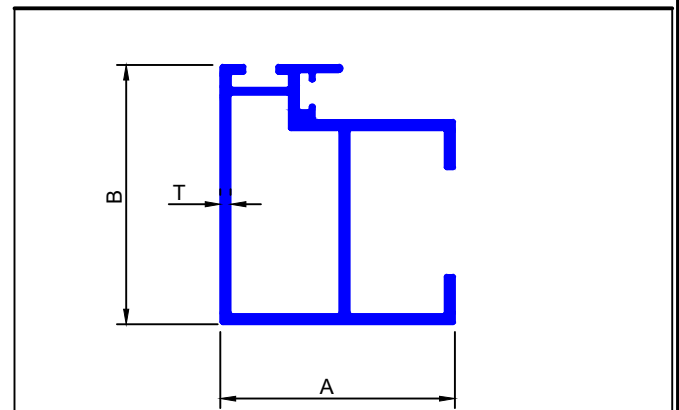

SEC.NO.	A	B	T	WT.Kg/mtr.
3028	31.00	34.31	1.35	0.523

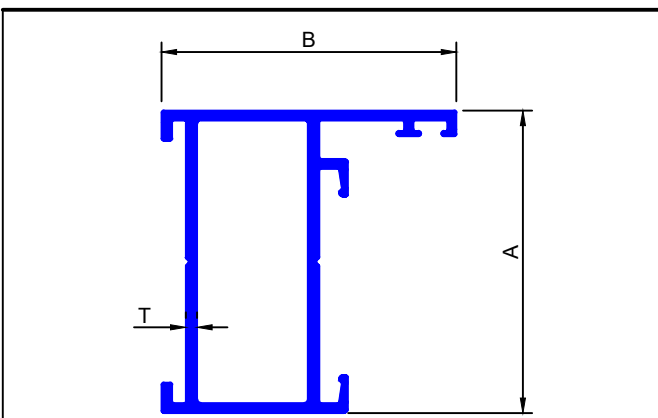

SEC.NO.	A	B	T	WT.Kg/mtr.
3029	40.00	39.00	1.50	0.598

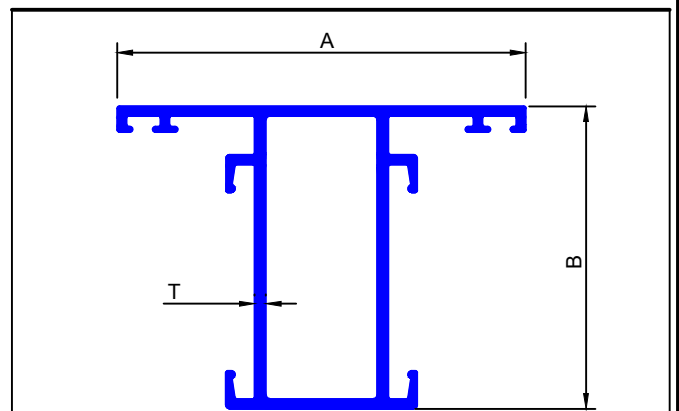

SEC.NO.	A	B	T	WT.Kg/mtr.
7000	54.00	40.00	1.50	0.687

SLIDING WINDOW

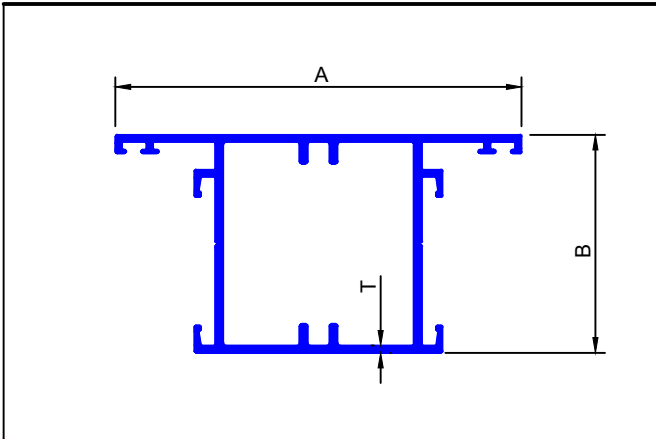

SEC.NO.	A	B	T	WT.Kg/mtr.
7001	74.60	40.00	1.30	0.895

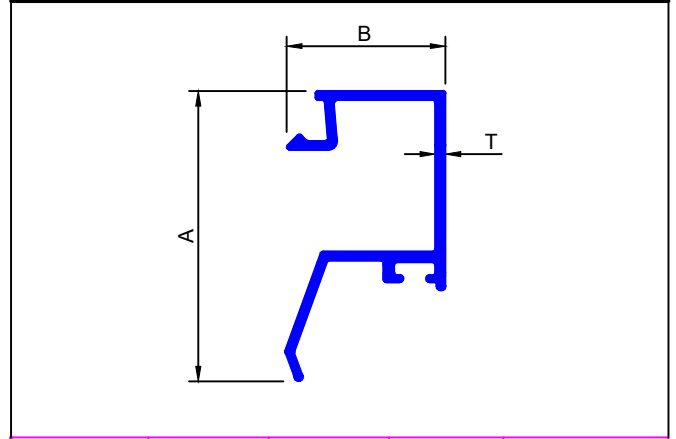

SEC.NO.	A	B	T	WT.Kg/mtr.
7002	32.00	17.50	1.15	0.218

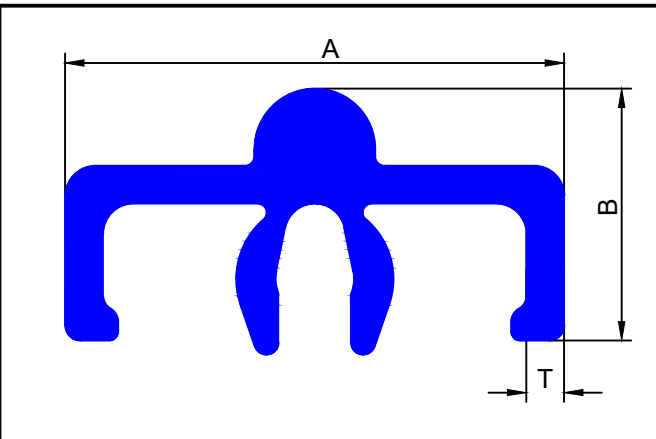

SEC.NO.	A	B	T	WT.Kg/mtr.
7003	16.50	8.30	1.25	0.141

CASEMENT WINDOW

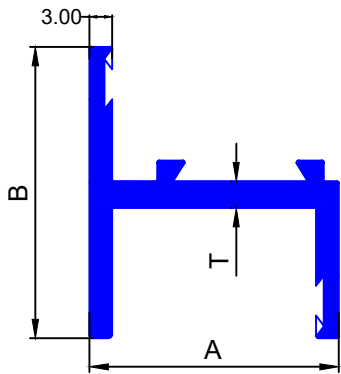

SEC.NO.	A	B	T	WT.Kg/mtr.
3051	33.00	38.50	3.50	0.749

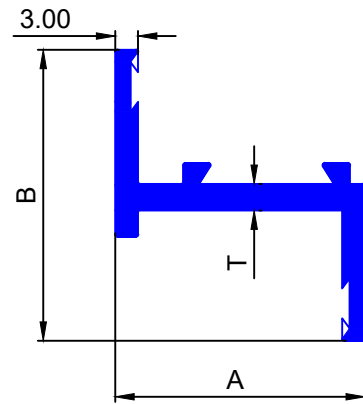

SEC.NO.	A	B	T	WT.Kg/mtr.
3052	33.00	38.50	3.50	0.638

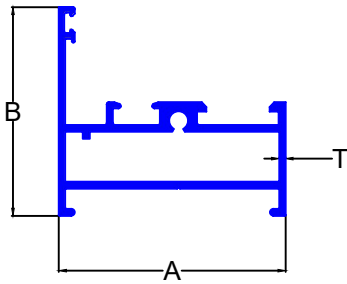

SEC.NO.	A	B	T	WT.Kg/mtr.
3055	50.00	46.00	1.40	0.808

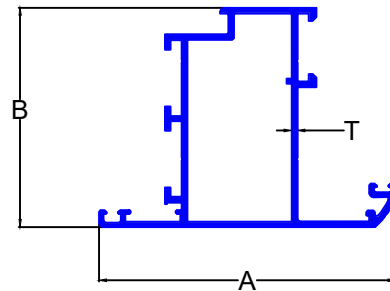

SEC.NO.	A	B	T	WT.Kg/mtr.
3056	78.50	58.00	1.50	1.138

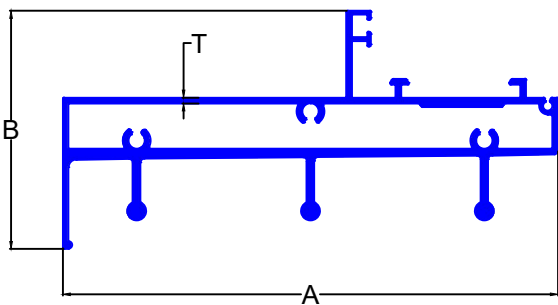

SEC.NO.	A	B	T	WT.Kg/mtr.
3057	131.00	63.00	1.50	2.268

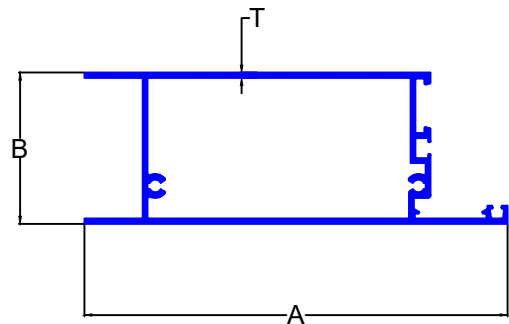

SEC.NO.	A	B	T	WT.Kg/mtr.
3058	140.00	50.00	1.80	1.881
3060	140.00	50.00	1.80	1.880

CASEMENT WINDOW

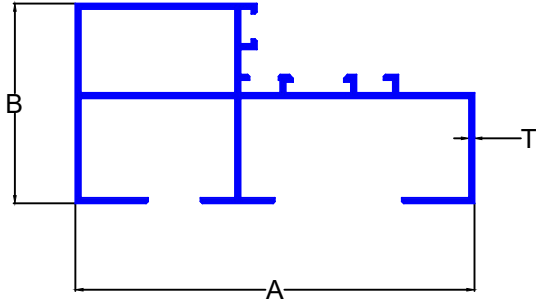

SEC.NO.	A	B	T	WT.Kg/mtr.
3059	110.00	55.00	1.50	1.540

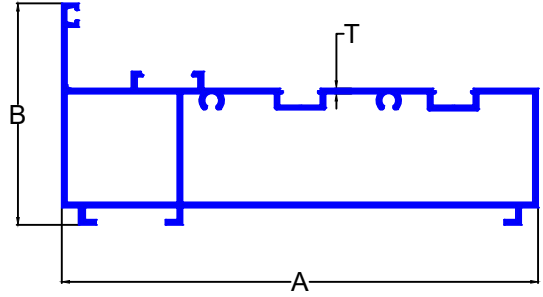

SEC.NO.	A	B	T	WT.Kg/mtr.
3061	140.00	65.12	1.50	1.975

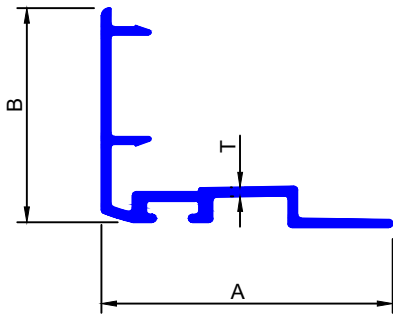

SEC.NO.	A	B	T	WT.Kg/mtr.
3062	38.50	28.30	1.20	0.283

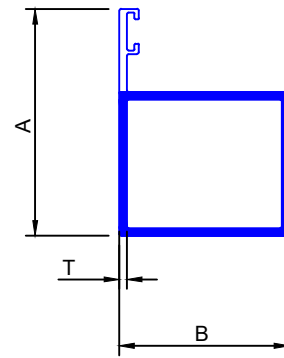

SEC.NO.	A	B	T	WT.Kg/mtr.
3063	60.00	45.00	2.00	1.000

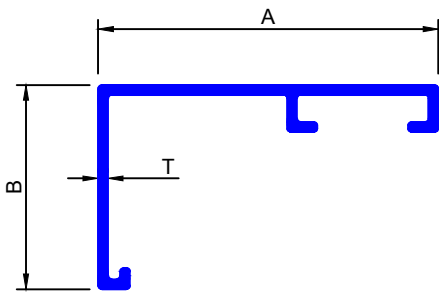

SEC.NO.	A	B	T	WT.Kg/mtr.
3064	45.00	27.00	1.30	0.316

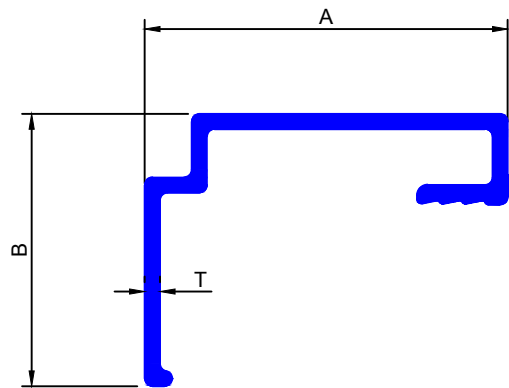

SEC.NO.	A	B	T	WT.Kg/mtr.
3065	24.00	18.00	1.00	0.141

CASEMENT WINDOW

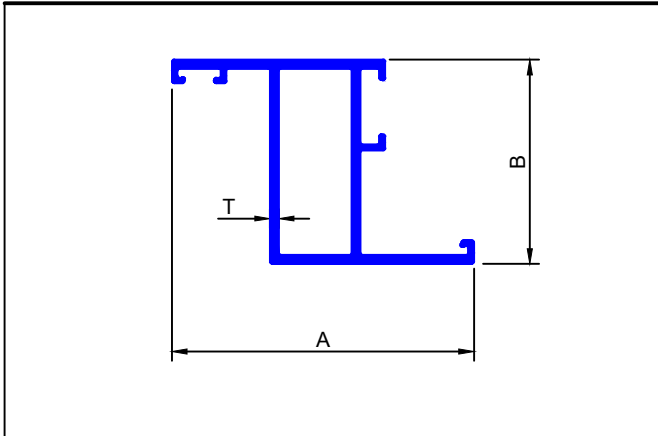

SEC.NO.	A	B	T	WT.Kg/mtr.
3066	66.60	45.00	2.00	1.026

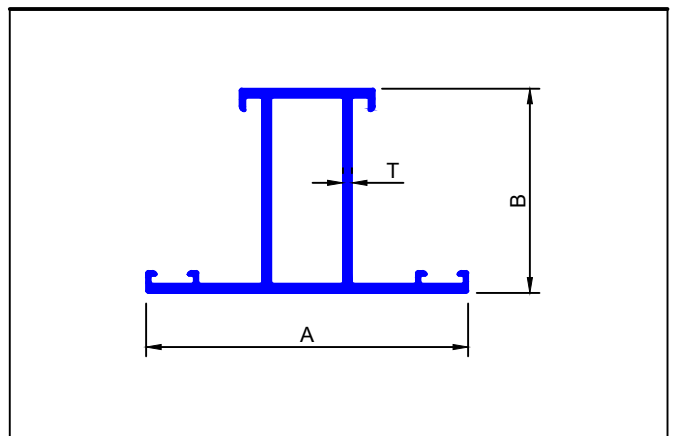

SEC.NO.	A	B	T	WT.Kg/mtr.
3067	71.00	45.00	2.00	1.051

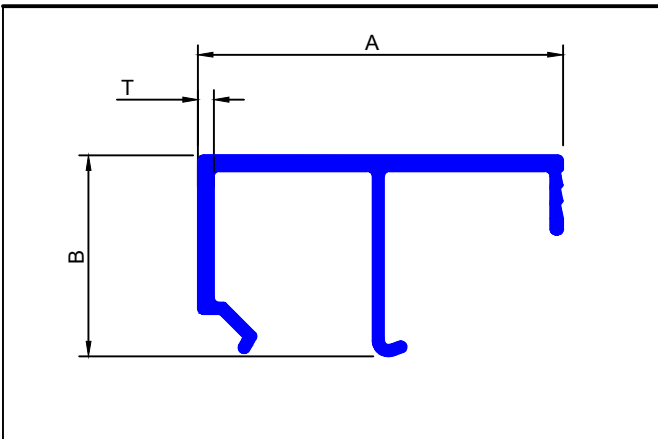

SEC.NO.	A	B	T	WT.Kg/mtr.
3068	34.50	19.00	1.50	0.285

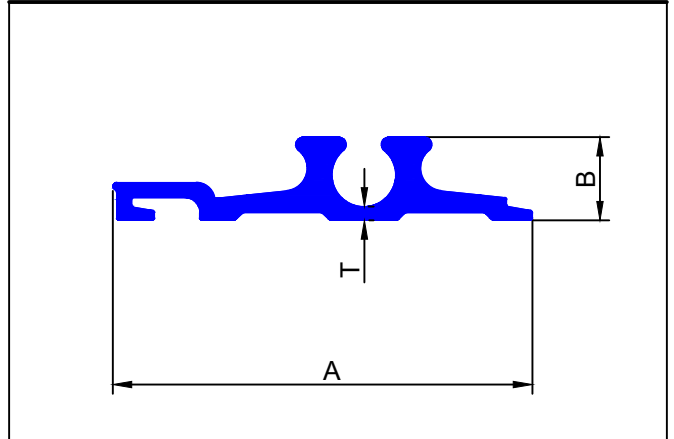

SEC.NO.	A	B	T	WT.Kg/mtr.
3069	55.50	11.00	1.80	0.600

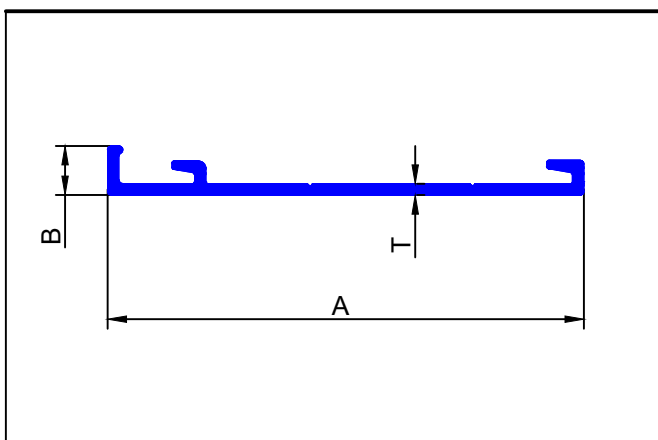

SEC.NO.	A	B	T	WT.Kg/mtr.
3070	63.00	6.50	1.50	0.322

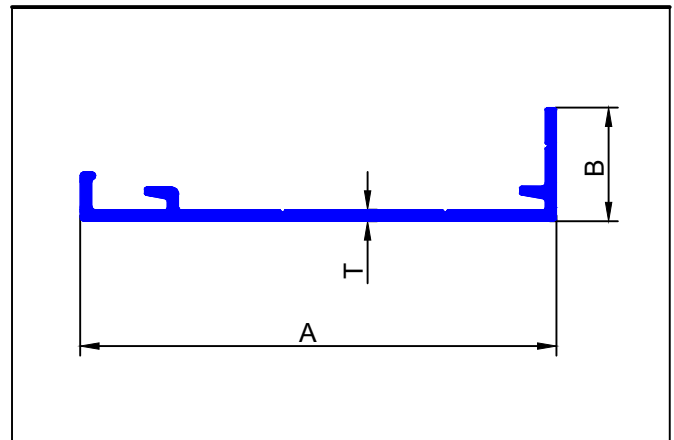

SEC.NO.	A	B	T	WT.Kg/mtr.
3071	63.00	15.00	1.50	0.364

CASEMENT WINDOW

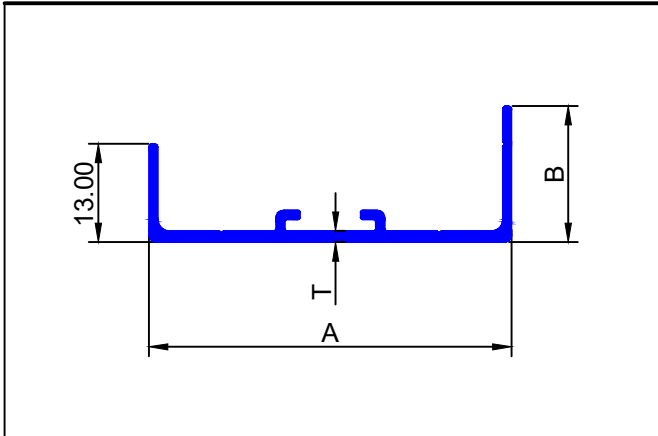

SEC.NO.	A	B	T	WT.Kg/mtr.
3072	48.00	18.00	1.50	0.314

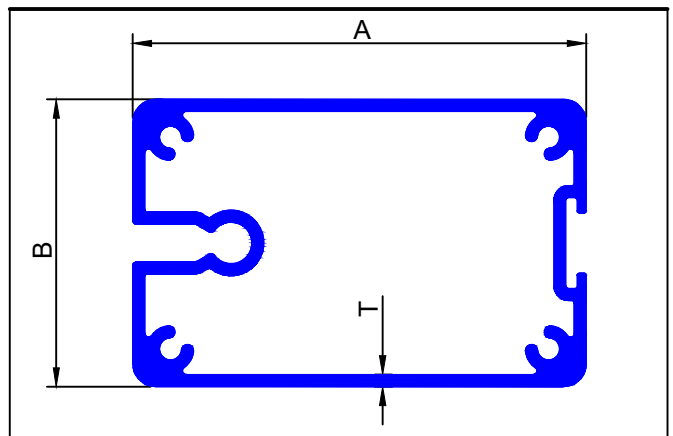

SEC.NO.	A	B	T	WT.Kg/mtr.
3073	60.00	38.00	1.60	1.221

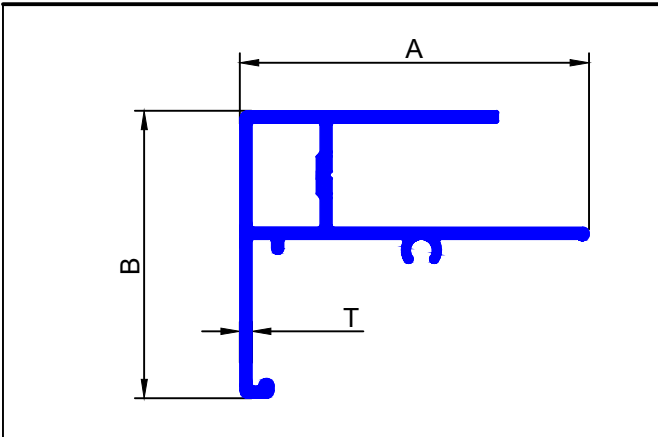

SEC.NO.	A	B	T	WT.Kg/mtr.
3074	46.20	38.00	1.60	0.609

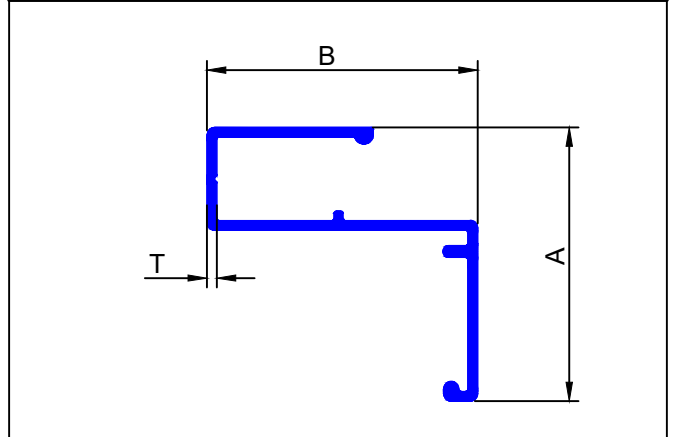

SEC.NO.	A	B	T	WT.Kg/mtr.
3075	36.20	35.80	1.30	0.356

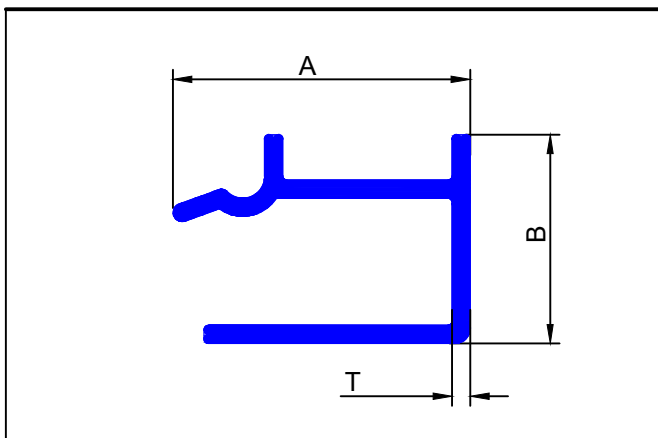

SEC.NO.	A	B	T	WT.Kg/mtr.
3076	19.65	13.80	1.20	0.168

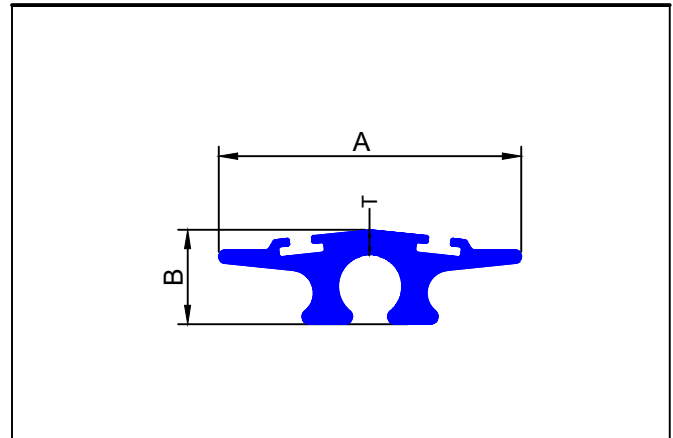

SEC.NO.	A	B	T	WT.Kg/mtr.
3077	40.00	12.50	3.30	0.498

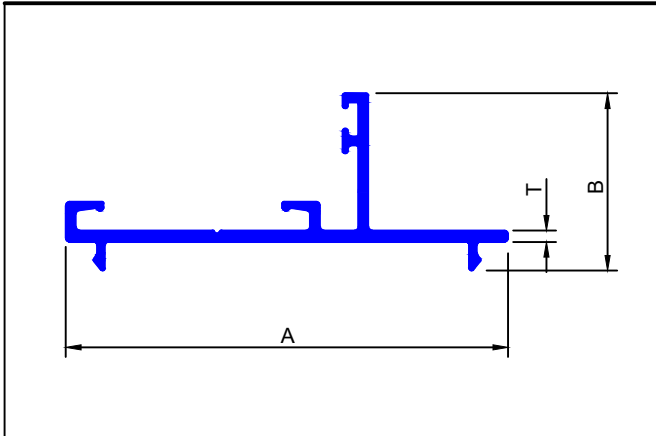

SEC.NO.	A	B	T	WT.Kg/mtr.
3078	58.50	23.43	1.50	0.388

KITCHEN SECTIONS

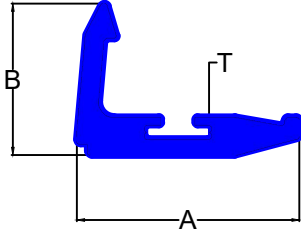

SEC.NO.	A	B	T	WT.Kg/mtr.
3285	29.50	20.00	5.00	0.400

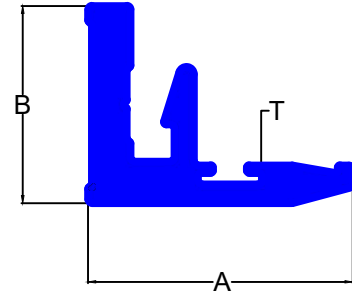

SEC.NO.	A	B	T	WT.Kg/mtr.
3286	35.00	26.00	5.00	0.775

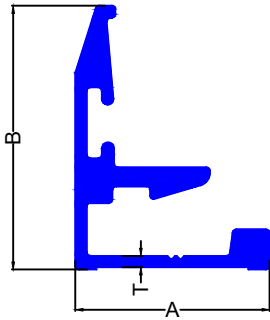

SEC.NO.	A	B	T	WT.Kg/mtr.
3287	25.70	34.90	1.50	0.518

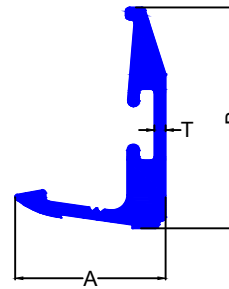

SEC.NO.	A	B	T	WT.Kg/mtr.
3288	19.90	29.20	1.50	0.347

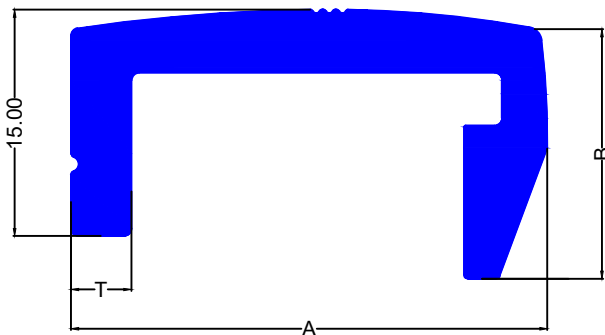

SEC.NO.	A	B	T	WT.Kg/mtr.
3289	31.50	16.50	4.00	0.569

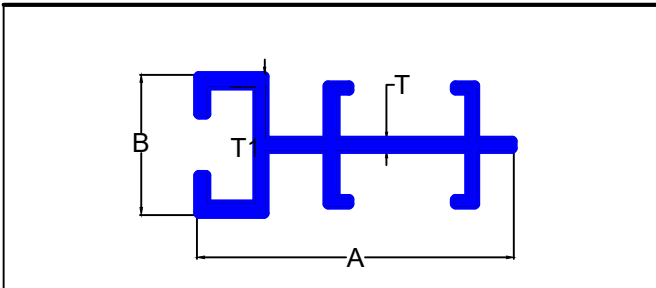

SEC.NO.	A	B	T	T1	WT.Kg/mtr.
3300	59.90	26.50	1.90	1.80	0.809

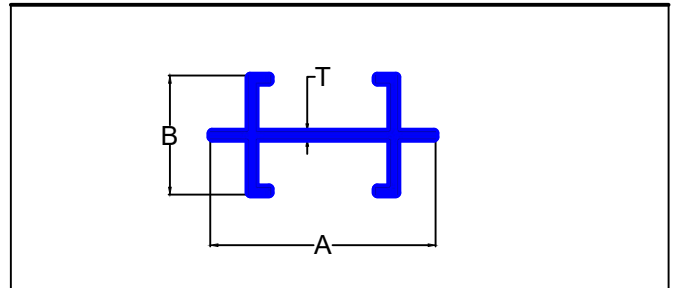

SEC.NO.	A	B	T	WT.Kg/mtr.
3304	43.60	22.50	1.20	0.318

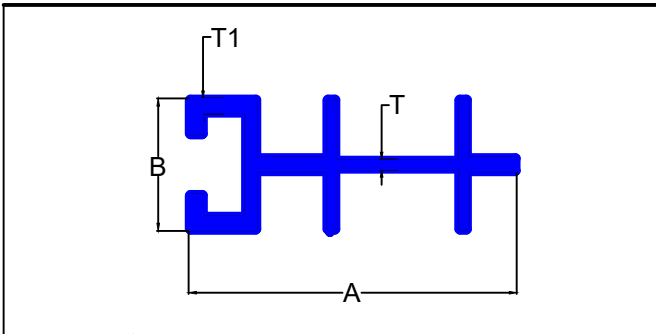

SEC.NO.	A	B	T	T1	WT.Kg/mtr.
3302	62.00	25.00	1.90	2.90	0.940

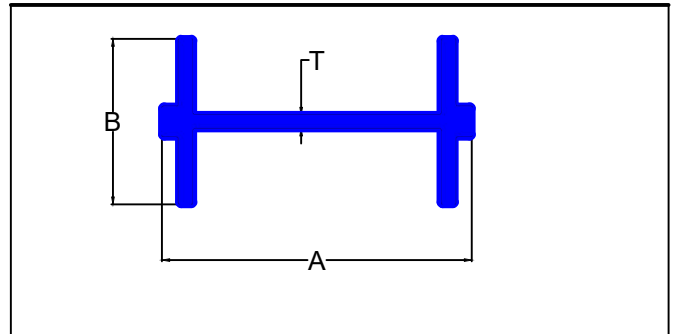

SEC.NO.	A	B	T	WT.Kg/mtr.
3305	41.00	21.90	1.80	0.432

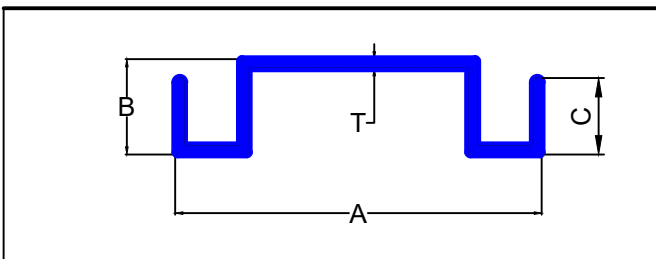

SEC.NO.	A	B	C	T	WT.Kg/mtr.
3307	48.50	12.70	10.00	1.30	0.311

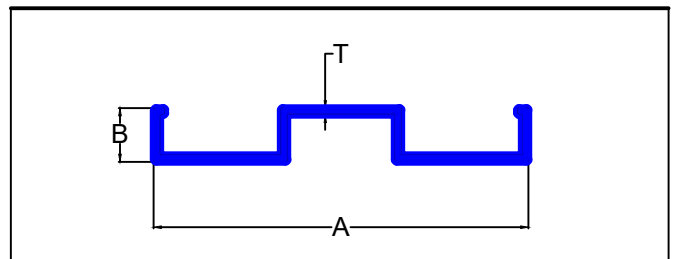

SEC.NO.	A	B	T	WT.Kg/mtr.
3309	98.50	13.60	1.15	0.468

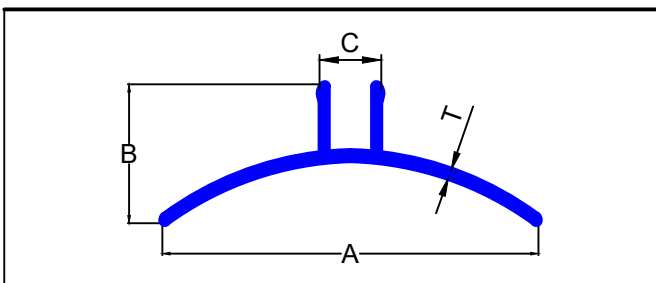

SEC.NO.	A	B	C	T	WT.Kg/mtr.
3310	82.90	30.60	13.58	1.65	0.487
3329	85.50	34.20	13.80	1.50	0.519

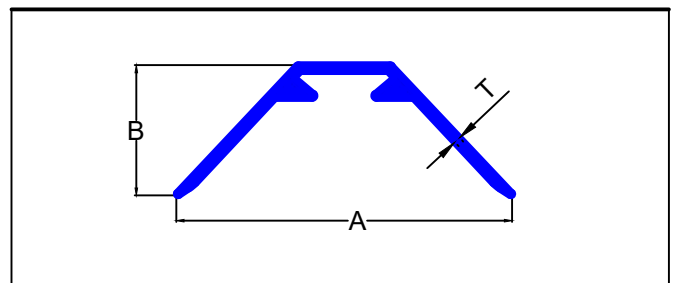

SEC.NO.	A	B	T	WT.Kg/mtr.
3312	74.00	28.70	1.45	0.474
3330	73.40	30.65	1.40	0.395

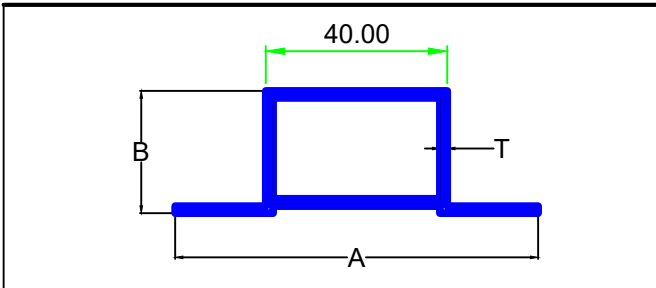

SEC.NO.	A	B	T	WT.Kg/mtr.
3314	80.00	27.00	1.60	0.724

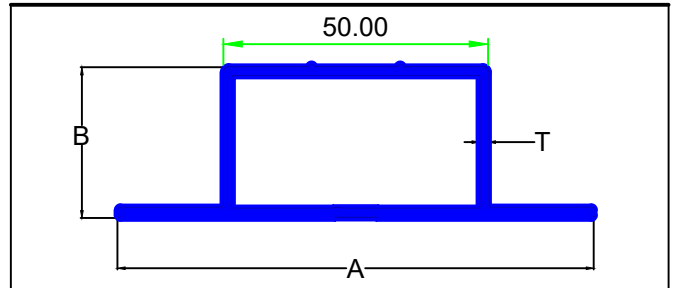

SEC.NO.	A	B	T	WT.Kg/mtr.
3315	90.00	28.50	1.60	0.892

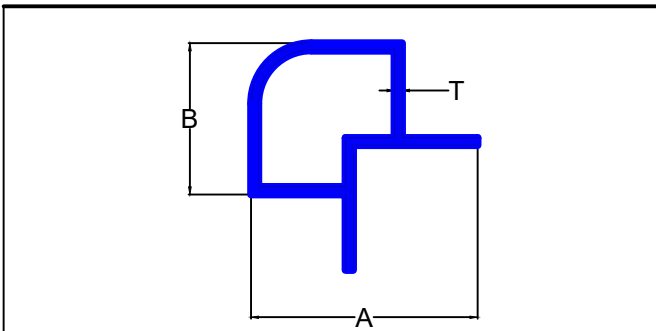

SEC.NO.	A	B	T	WT.Kg/mtr.
3316	60.00	40.00	2.00	0.994

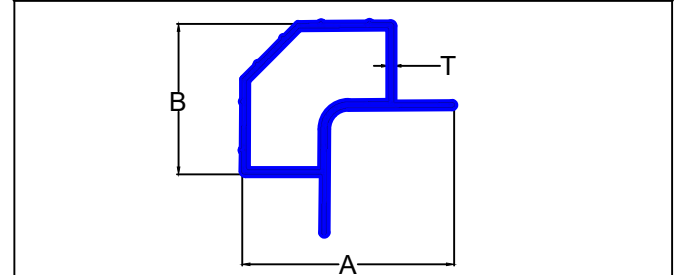

SEC.NO.	A	B	T	WT.Kg/mtr.
3319	70.00	50.00	1.50	0.950

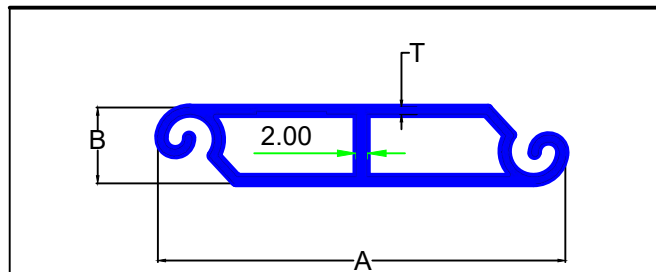

SEC.NO.	A	B	T	WT.Kg/mtr.
3320	77.00	14.30	1.25	0.669

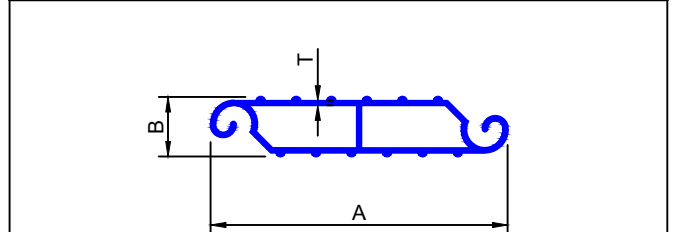

SEC.NO.	A	B	T	WT.Kg/mtr.
3323	77.00	15.50	1.20	0.659

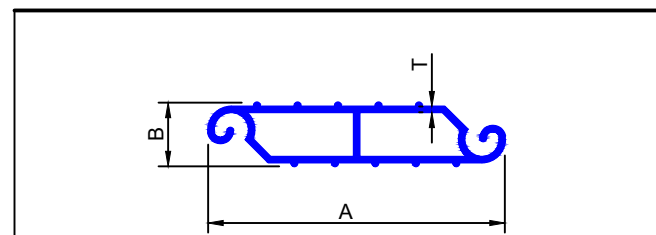

SEC.NO.	A	B	T	WT.Kg/mtr.
3324	77.00	16.50	1.50	0.790

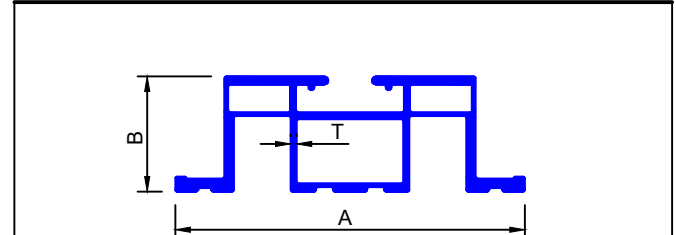

SEC.NO.	A	B	T	WT.Kg/mtr.
3325	92.50	30.50	1.60	1.495

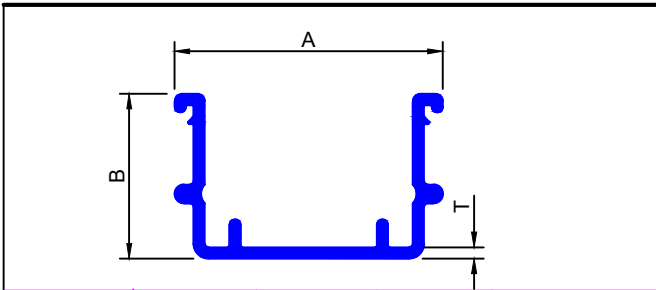

SEC.NO.	A	B	T	WT.Kg/mtr.
3326	35.50	21.80	1.50	0.365

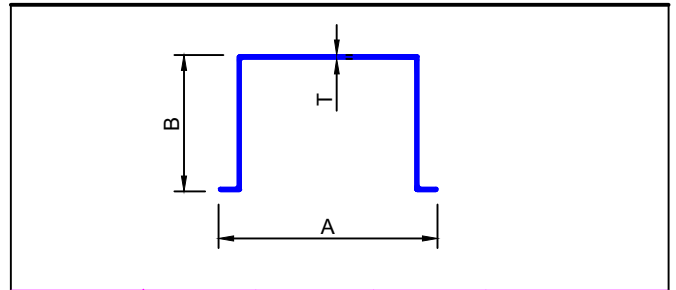

SEC.NO.	A	B	T	WT.Kg/mtr.
3327	58.00	36.00	1.00	0.345

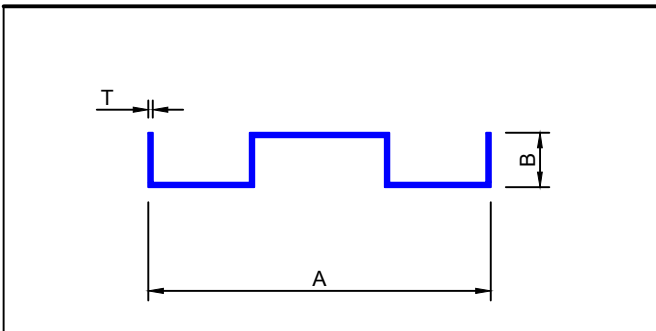

SEC.NO.	A	B	T	WT.Kg/mtr.
3328	75.50	12.00	1.00	0.322

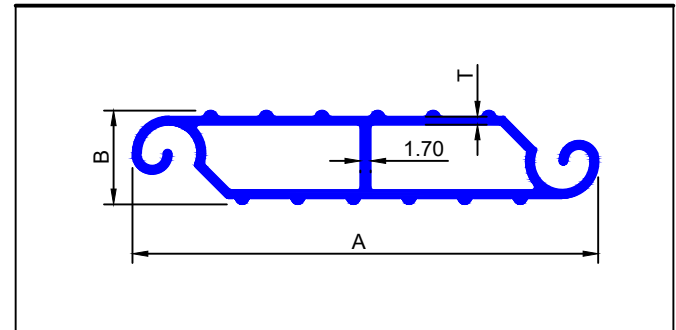

SEC.NO.	A	B	T	WT.Kg/mtr.
3332	77.00	15.50	1.35	0.742

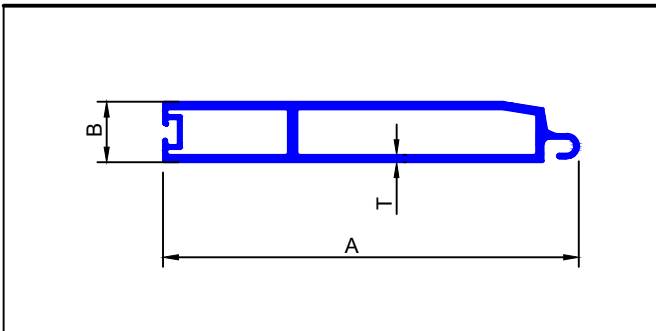

SEC.NO.	A	B	T	WT.Kg/mtr.
3333	110.00	16.00	2.00	1.366

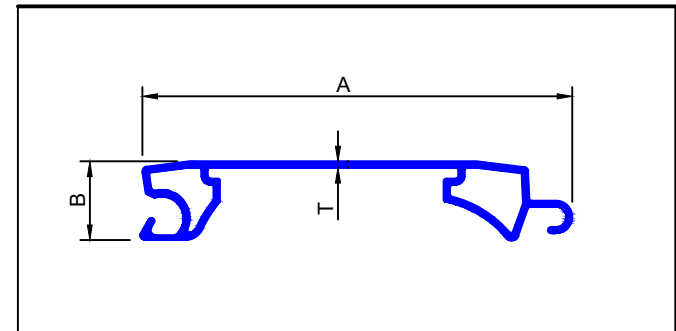

SEC.NO.	A	B	T	WT.Kg/mtr.
3334	87.54	16.00	1.30	0.635

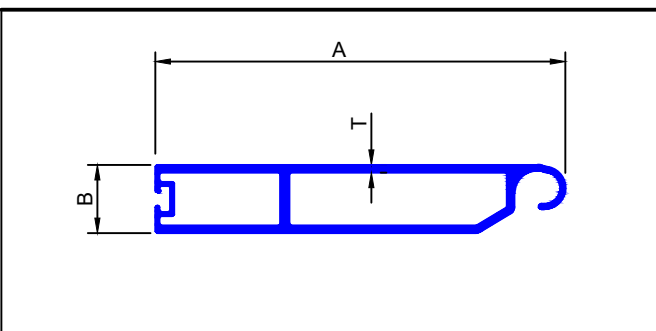

SEC.NO.	A	B	T	WT.Kg/mtr.
3335	108.50	18.00	2.00	1.371

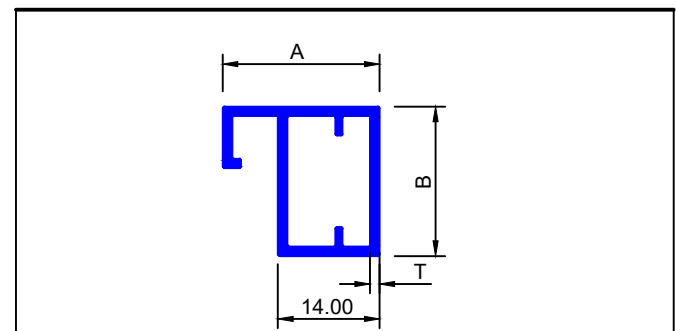

SEC.NO.	A	B	T	WT.Kg/mtr.
3336	21.60	20.60	1.30	0.295

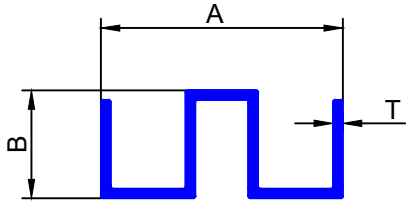

SEC.NO.	A	B	T	WT.Kg/mtr.
3337	32.00	14.30	1.30	0.285

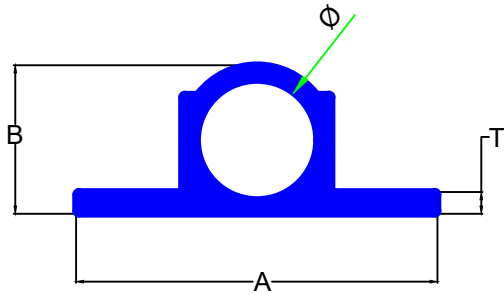

SEC.NO.	A	B	T	Ø	WT.Kg/mtr.
3354	38.00	16.70	2.30	16.20	0.472

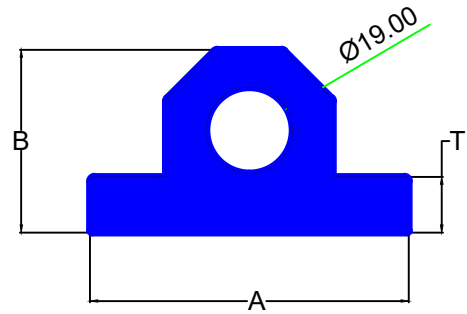

SEC.NO.	A	B	T	WT.Kg/mtr.
3355	70.30	40.30	12.30	4.033

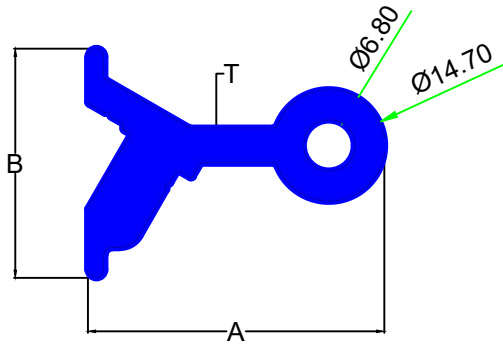

SEC.NO.	A	B	T	WT.Kg/mtr.
3356	39.20	30.30	4.60	1.023

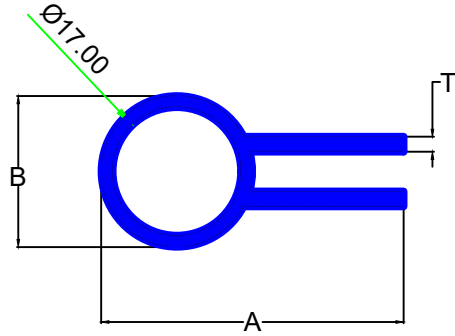

SEC.NO.	A	B	T	WT.Kg/mtr.
3357	40.00	20.00	2.00	0.454

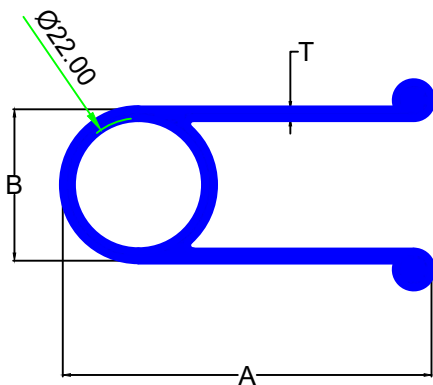

SEC.NO.	A	B	T	WT.Kg/mtr.
3358	61.00	25.00	1.50	0.781

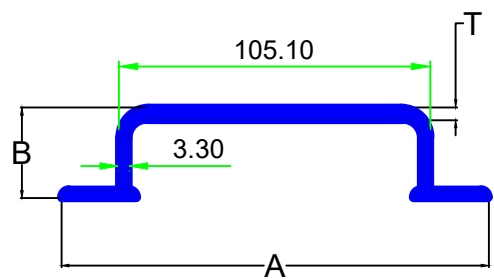

SEC.NO.	A	B	T	WT.Kg/mtr.
3362	144.50	30.70	4.30	1.964

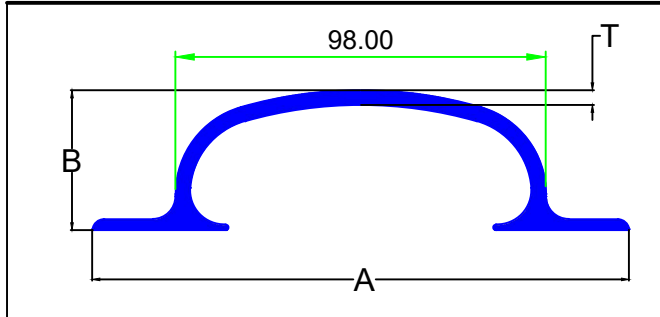

SEC.NO.	A	B	T	WT.Kg/mtr.
3363	142.00	37.00	3.85	1.998

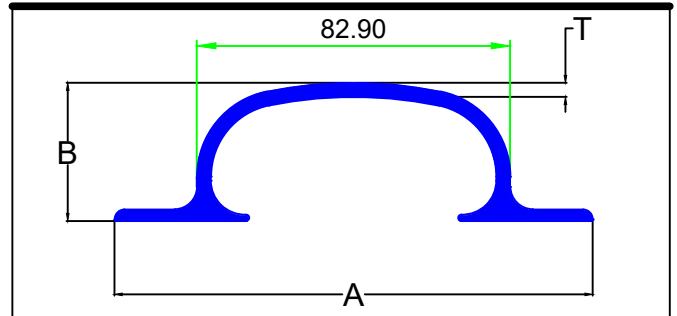

SEC.NO.	A	B	T	WT.Kg/mtr.
3364	126.50	36.50	3.70	1.832

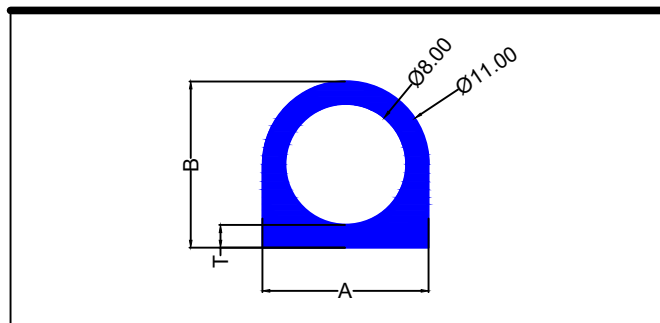

SEC.NO.	A	B	T	WT.Kg/mtr.
3365	11.00	11.00	1.50	0.155

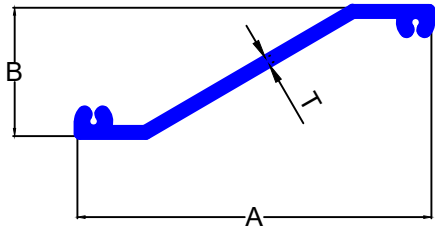

SEC.NO.	A	B	T	WT.Kg/mtr.
3453	78.00	28.30	1.60	0.460
3459	78.00	28.30	1.40	0.380

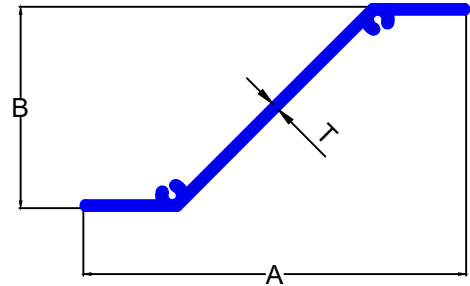

SEC.NO.	A	B	T	WT.Kg/mtr.
3454	101.30	53.25	1.35	0.514

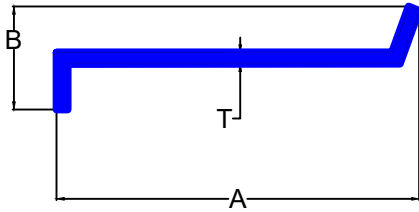

SEC.NO.	A	B	T	WT.Kg/mtr.
3458	80.00	22.70	2.50	0.651

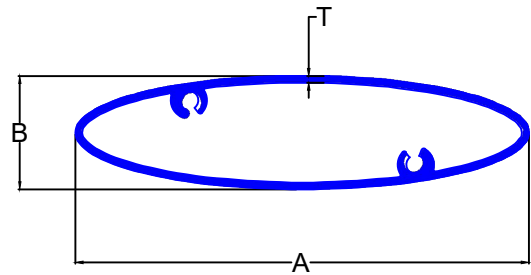

SEC.NO.	A	B	T	WT.Kg/mtr.
3460	100.00	25.00	1.50	0.967

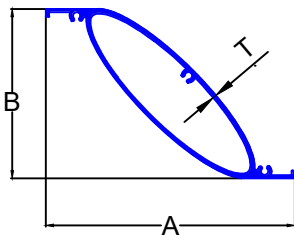

SEC.NO.	A	B	T	WT.Kg/mtr.
3461	156.77	106.47	2.23	2.529

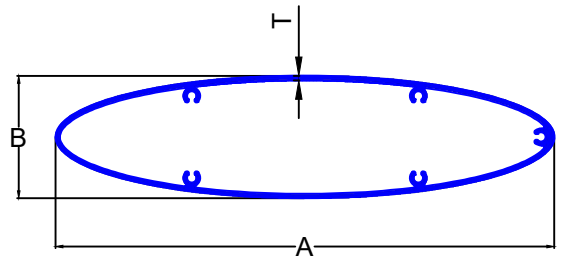

SEC.NO.	A	B	T	WT.Kg/mtr.
3462	219.99	54.00	2.00	2.891

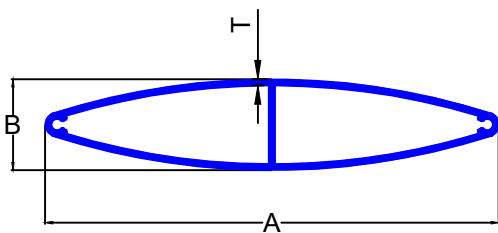

SEC.NO.	A	B	T	WT.Kg/mtr.
3463	150.00	30.00	2.00	1.834

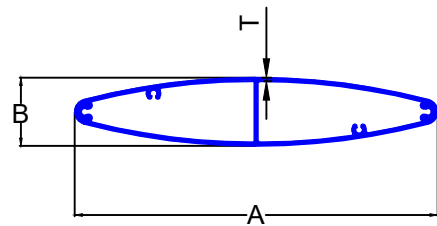

SEC.NO.	A	B	T	WT.Kg/mtr.
3464	160.00	30.02	1.50	1.685

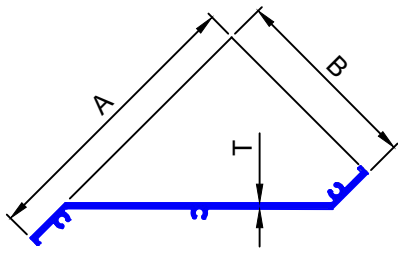

SEC.NO.	A	B	T	WT.Kg/mtr.
3465	156.80	106.10	3.00	1.884

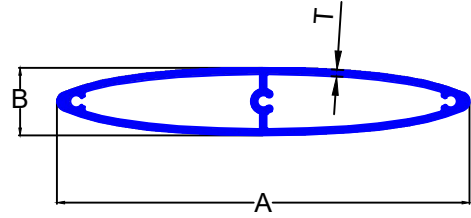

SEC.NO.	A	B	T	WT.Kg/mtr.
3466	140.00	23.00	2.25	1.954

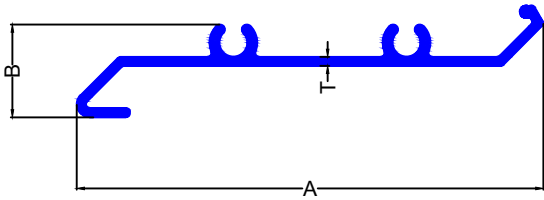

SEC.NO.	A	B	T	WT.Kg/mtr.
3467	61.70	12.25	1.20	0.308

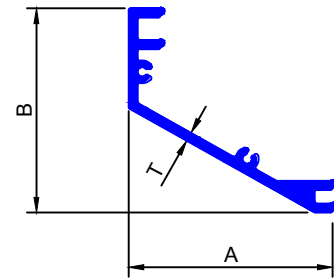

SEC.NO.	A	B	T	WT.Kg/mtr.
3468	45.00	45.00	2.00	0.560

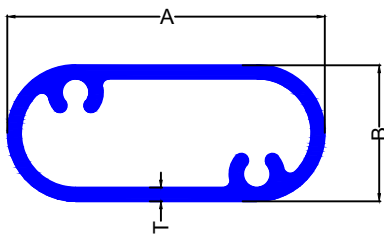

SEC.NO.	A	B	T	WT.Kg/mtr.
3469	35.00	15.00	1.50	0.397

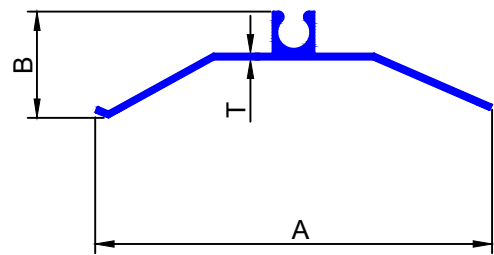

SEC.NO.	A	B	T	WT.Kg/mtr.
3470	150.00	40.16	2.30	1.265

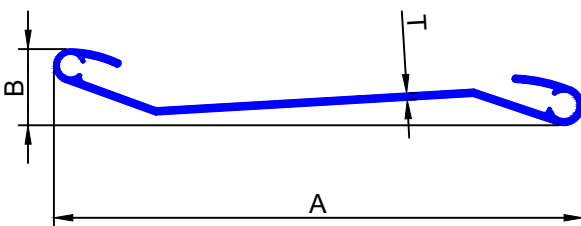

SEC.NO.	A	B	T	WT.Kg/mtr.
3471	99.99	14.39	1.25	0.557

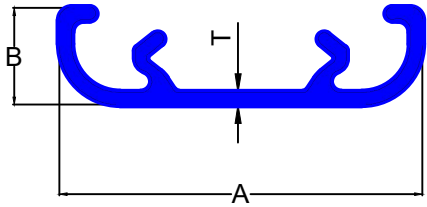

SEC.NO.	A	B	T	WT.Kg/mtr.
3800	30.00	8.00	1.00	0.153

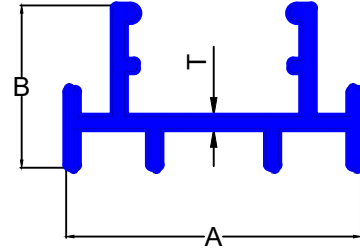

SEC.NO.	A	B	T	WT.Kg/mtr.
3801	30.00	16.50	1.20	0.257

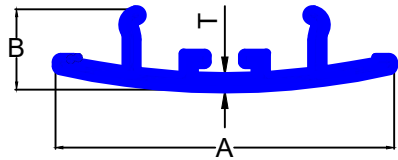

SEC.NO.	A	B	T	WT.Kg/mtr.
3802	32.00	7.60	1.30	0.175

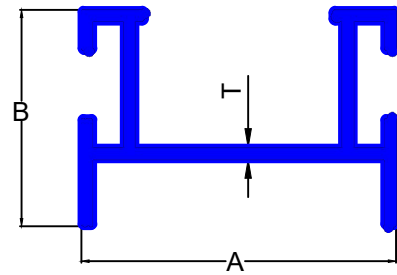

SEC.NO.	A	B	T	WT.Kg/mtr.
3803	32.00	22.00	1.20	0.310

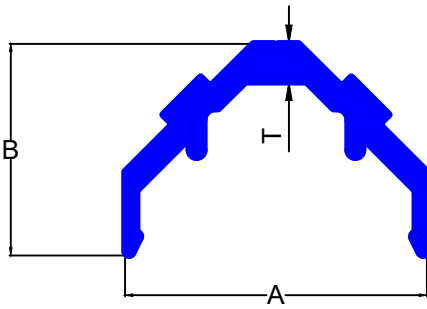

SEC.NO.	A	B	T	WT.Kg/mtr.
3804	40.00	28.00	5.00	0.604

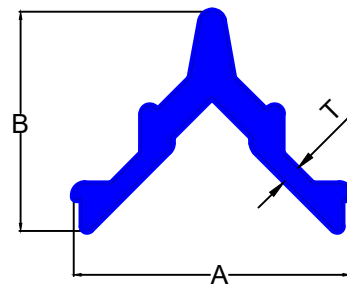

SEC.NO.	A	B	T	WT.Kg/mtr.
3805	36.60	29.00	2.30	0.573

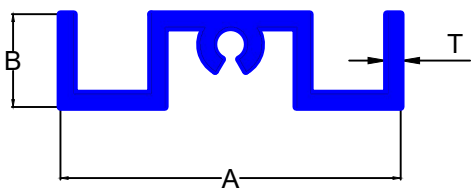

SEC.NO.	A	B	T	WT.Kg/mtr.
3806	30.00	8.20	1.20	0.213

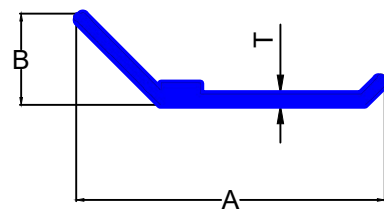

SEC.NO.	A	B	T	WT.Kg/mtr.
3807	31.40	9.30	1.10	0.116

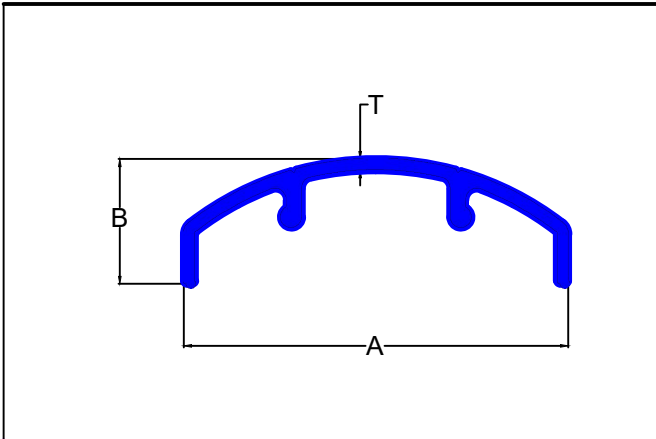

SEC.NO.	A	B	T	WT.Kg/mtr.
3808	50.90	16.50	1.50	0.350

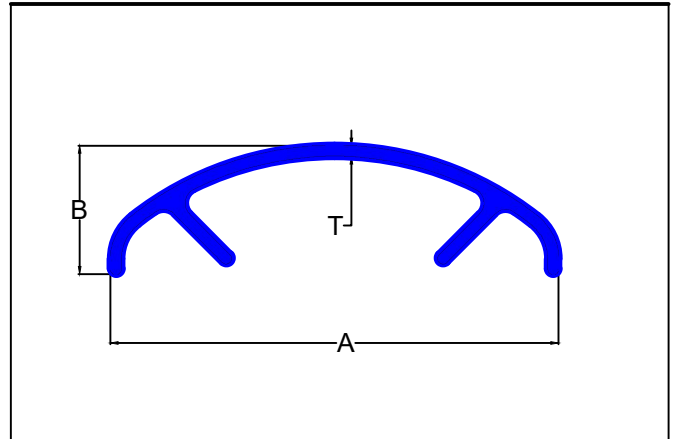

SEC.NO.	A	B	T	WT.Kg/mtr.
3809	74.00	21.20	1.80	0.593

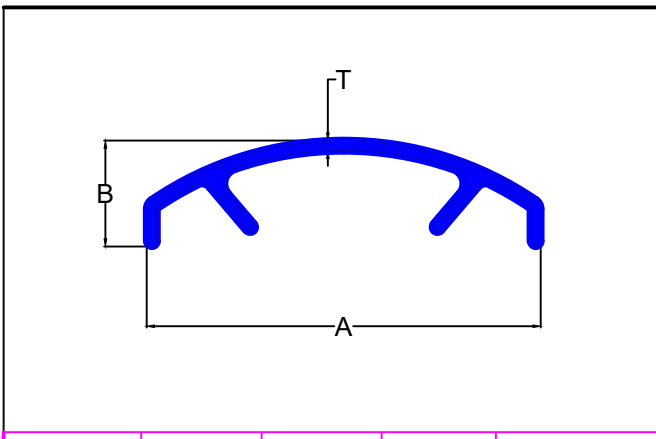

SEC.NO.	A	B	T	WT.Kg/mtr.
3810	74.50	20.00	1.90	0.633

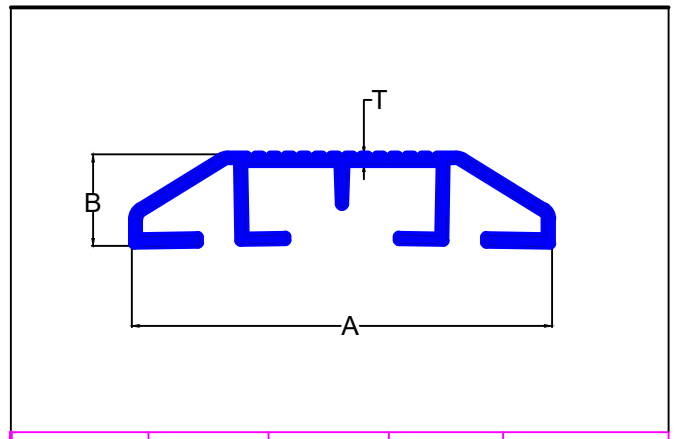

SEC.NO.	A	B	T	WT.Kg/mtr.
3811	55.60	12.00	1.30	0.349

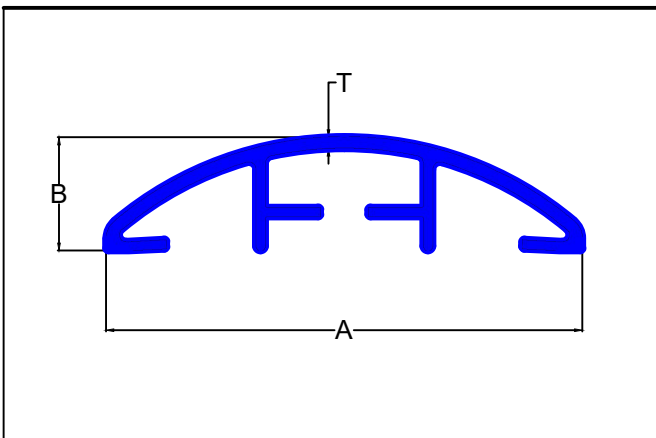

SEC.NO.	A	B	T	WT.Kg/mtr.
3812	63.00	15.00	1.50	0.464

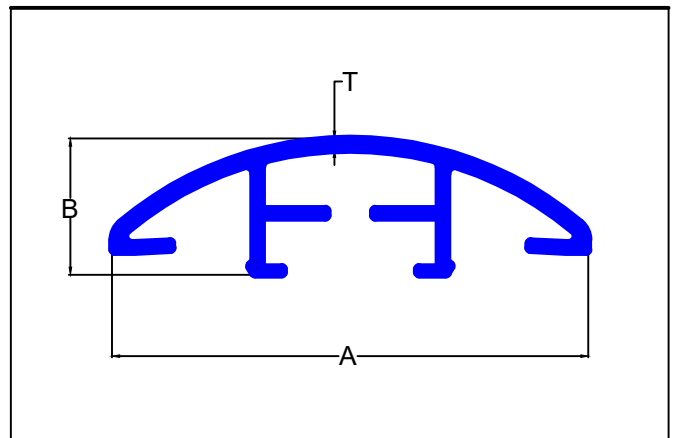

SEC.NO.	A	B	T	WT.Kg/mtr.
3813	63.00	18.00	1.50	0.509

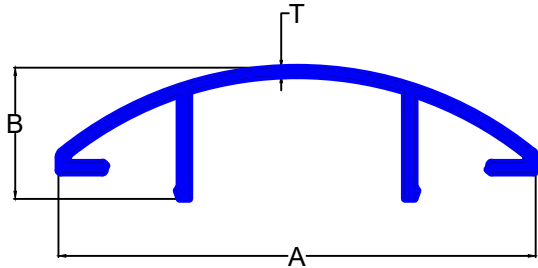

SEC.NO.	A	B	T	WT.Kg/mtr.
3814	63.80	17.50	1.00	0.327

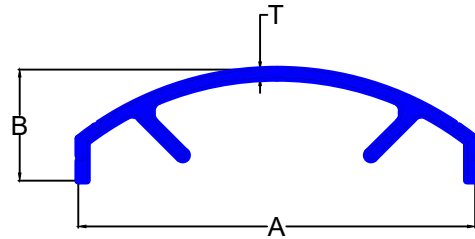

SEC.NO.	A	B	T	WT.Kg/mtr.
3815	75.00	21.00	1.60	0.525

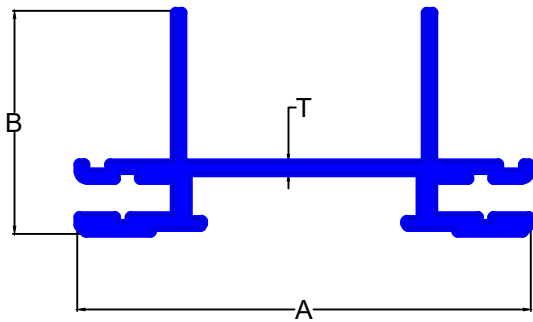

SEC.NO.	A	B	T	WT.Kg/mtr.
3818	60.00	29.50	1.50	0.654

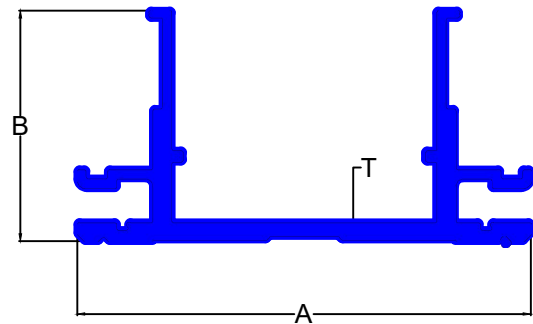

SEC.NO.	A	B	T	WT.Kg/mtr.
3819	60.00	30.50	2.30	0.748

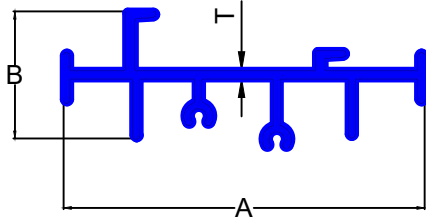

SEC.NO.	A	B	T	WT.Kg/mtr.
3820	30.00	8.00	1.00	0.466

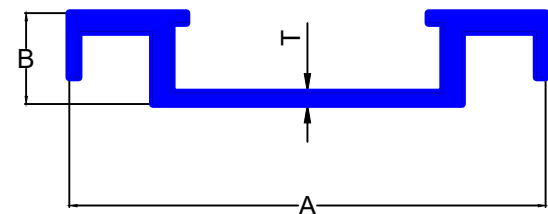

SEC.NO.	A	B	T	WT.Kg/mtr.
3821	63.00	12.00	1.50	0.509

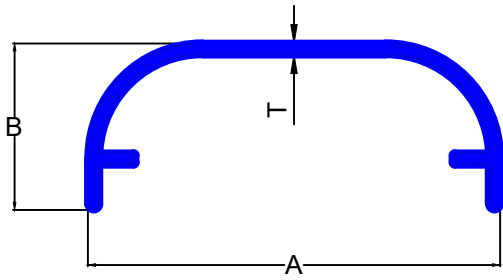

SEC.NO.	A	B	T	WT.Kg/mtr.
3822	54.00	21.80	1.50	0.370

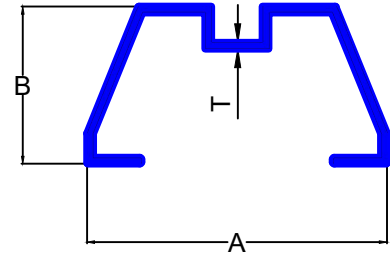

SEC.NO.	A	B	T	WT.Kg/mtr.
3824	49.60	26.00	1.00	0.304

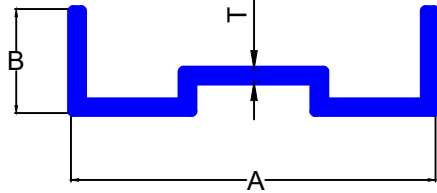

SEC.NO.	A	B	T	WT.Kg/mtr.
3825	60.30	17.20	2.00	0.545

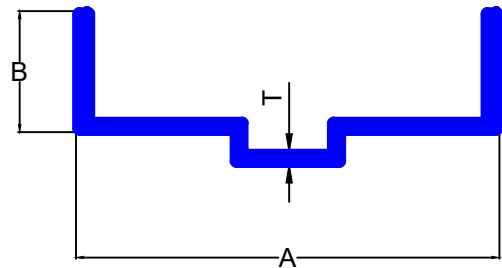

SEC.NO.	A	B	T	WT.Kg/mtr.
3826	70.00	20.00	1.90	0.657

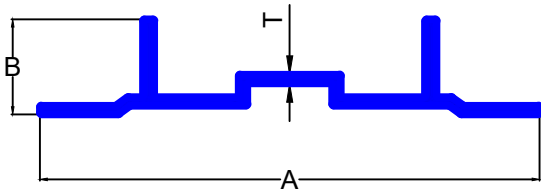

SEC.NO.	A	B	T	WT.Kg/mtr.
3827	110.20	20.00	1.90	0.853

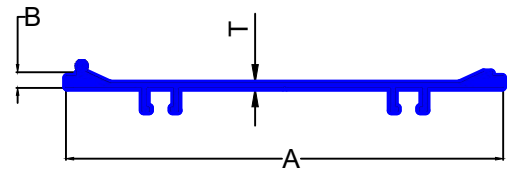

SEC.NO.	A	B	T	WT.Kg/mtr.
3828	144.50	5.20	1.50	0.906

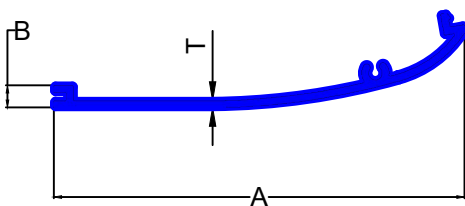

SEC.NO.	A	B	T	WT.Kg/mtr.
3829	90.50	4.90	1.50	0.468

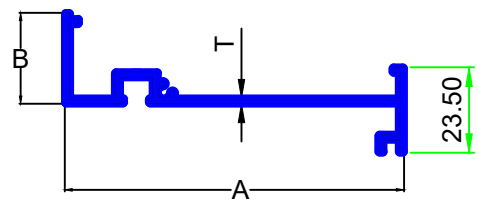

SEC.NO.	A	B	T	WT.Kg/mtr.
3830	93.50	25.00	1.50	0.702

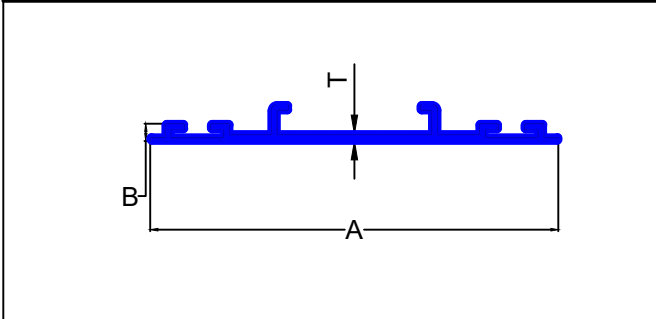

SEC.NO.	A	B	T	WT.Kg/mtr.
3831	108.00	4.50	1.80	0.631

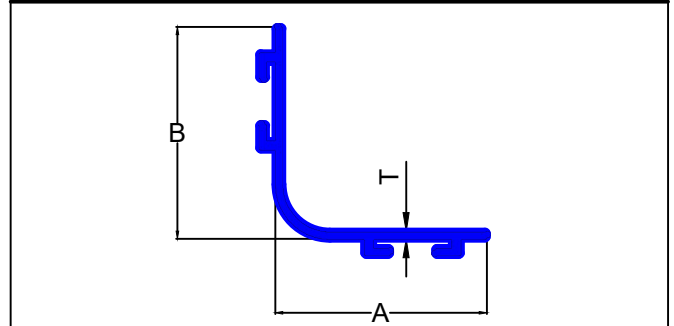

SEC.NO.	A	B	T	WT.Kg/mtr.
3832	35.00	35.00	1.20	0.291

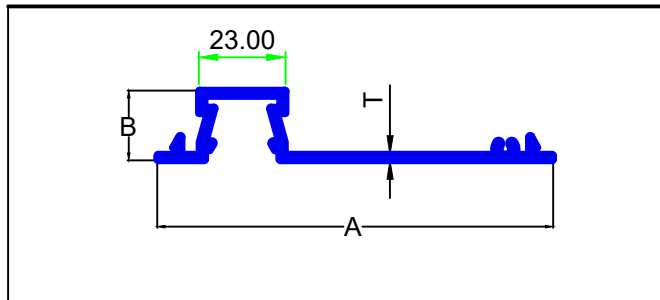

SEC.NO.	A	B	T	WT.Kg/mtr.
3834	104.75	18.50	1.50	0.676

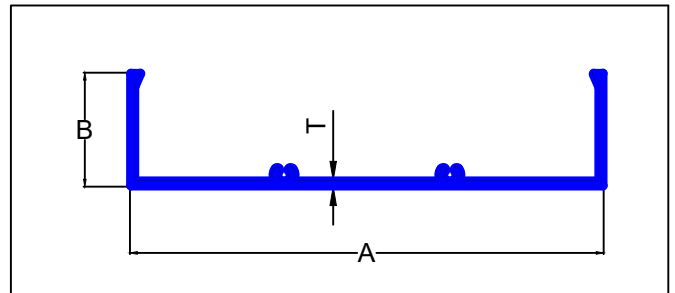

SEC.NO.	A	B	T	WT.Kg/mtr.
3835	125.40	30.20	1.70	0.886

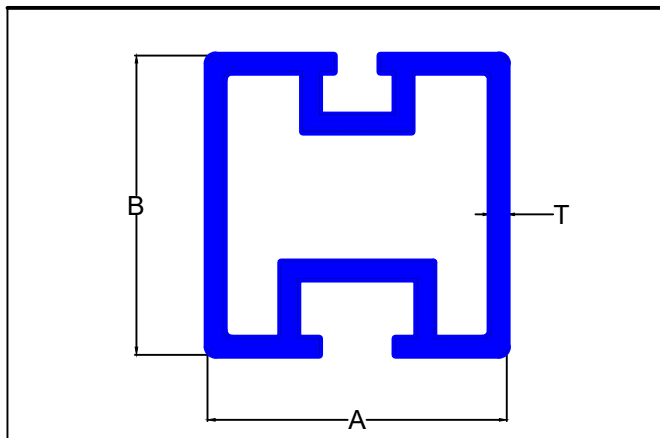

SEC.NO.	A	B	T	WT.Kg/mtr.
3836	55.00	55.00	3.00	2.199

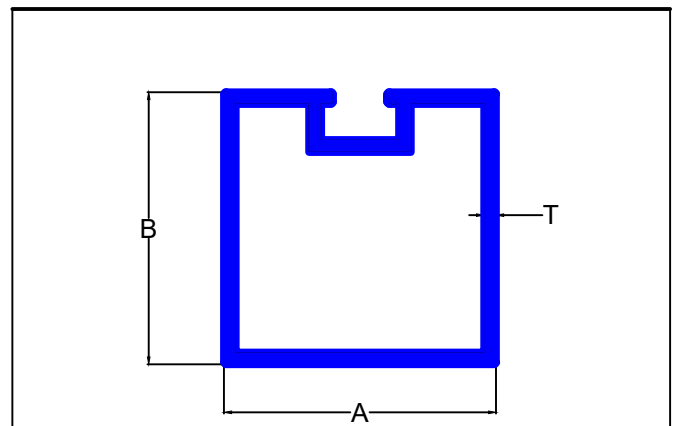

SEC.NO.	A	B	T	WT.Kg/mtr.
3837	45.00	45.00	2.00	1.025

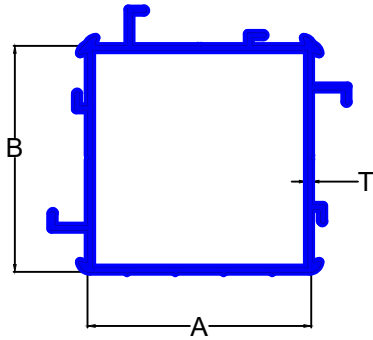

SEC.NO.	A	B	T	WT.Kg/mtr.
3838	59.20	59.30	1.20	1.032

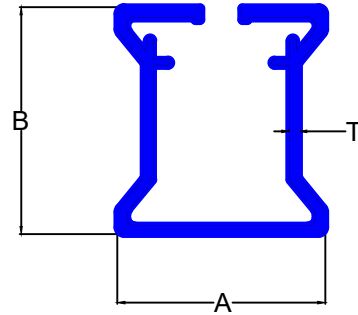

SEC.NO.	A	B	T	WT.Kg/mtr.
3839	55.00	60.00	2.60	1.626

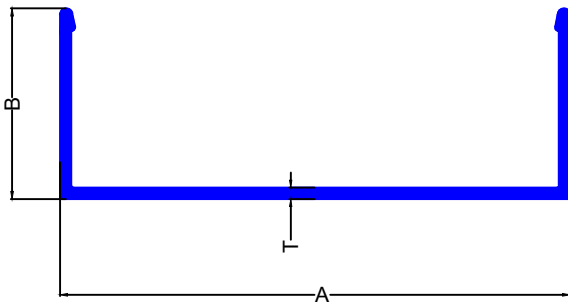

SEC.NO.	A	B	T	WT.Kg/mtr.
3841	67.50	25.20	1.50	0.468

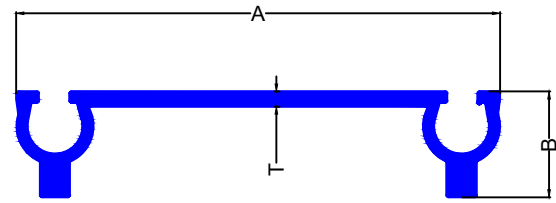

SEC.NO.	A	B	T	WT.Kg/mtr.
3842	64.00	14.00	2.00	0.545

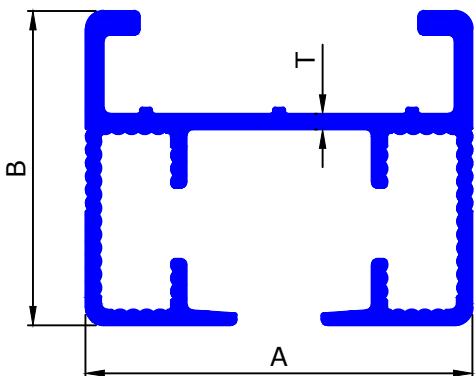

SEC.NO.	A	B	T	WT.Kg/mtr.
3843	32.00	26.00	1.30	0.462

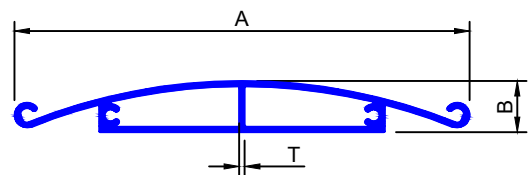

SEC.NO.	A	B	T	WT.Kg/mtr.
3844	100.40	11.30	1.20	0.688

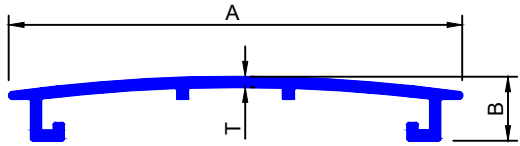

SEC.NO.	A	B	T	WT.Kg/mtr.
3845	60.00	8.50	1.40	0.306

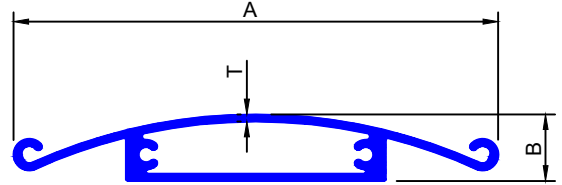

SEC.NO.	A	B	T	WT.Kg/mtr.
3846	80.20	11.00	1.20	0.590

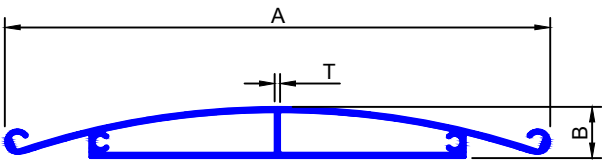

SEC.NO.	A	B	T	WT.Kg/mtr.
3847	120.20	11.30	1.20	0.791

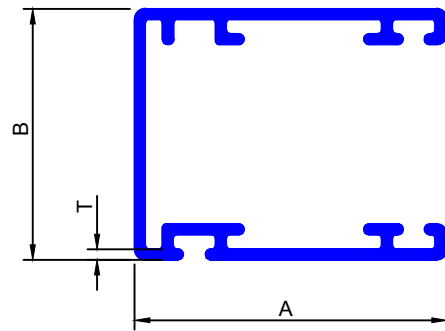

SEC.NO.	A	B	T	WT.Kg/mtr.
3848	41.30	33.20	1.40	0.588

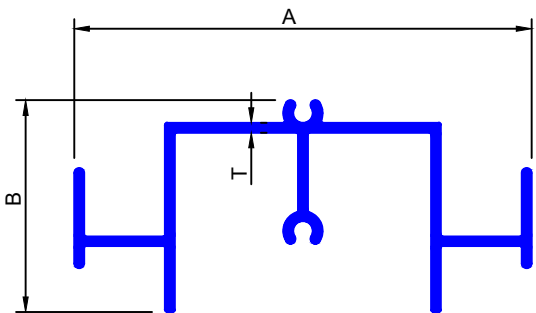

SEC.NO.	A	B	T	WT.Kg/mtr.
3849	60.50	28.00	1.30	0.552

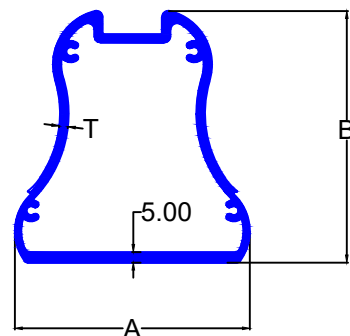

SEC.NO.	A	B	T	WT.Kg/mtr.
3850	111.10	118.86	4.00	5.017

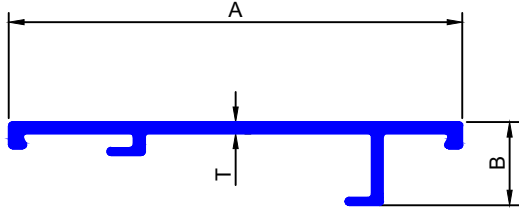

SEC.NO.	A	B	T	WT.Kg/mtr.
3851	60.00	11.00	1.50	0.334

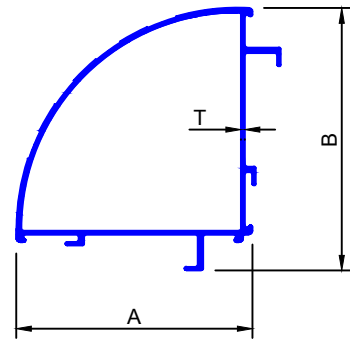

SEC.NO.	A	B	T	WT.Kg/mtr.
3852	62.50	69.42	1.00	0.801

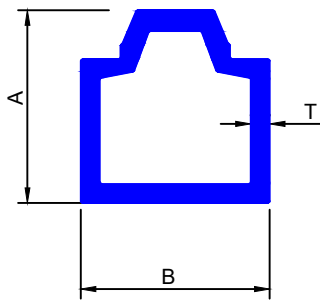

SEC.NO.	A	B	T	WT.Kg/mtr.
3853	51.00	50.00	5.00	2.344

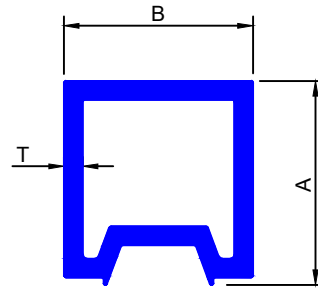

SEC.NO.	A	B	T	WT.Kg/mtr.
3854	54.00	50.00	5.00	2.640

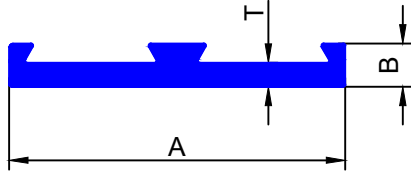

SEC.NO.	A	B	T	WT.Kg/mtr.
6200	44.45	5.72	3.18	0.462