

SEC.NO.	A	B	T	WT.Kg/mtr.
3900	23.00	21.20	2.75	0.600

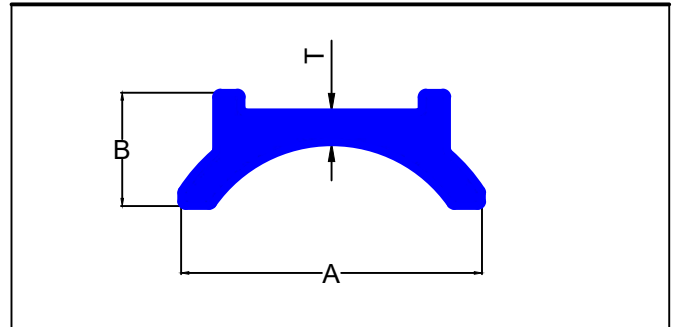

SEC.NO.	A	B	T	WT.Kg/mtr.
3903	19.90	7.50	2.00	0.171

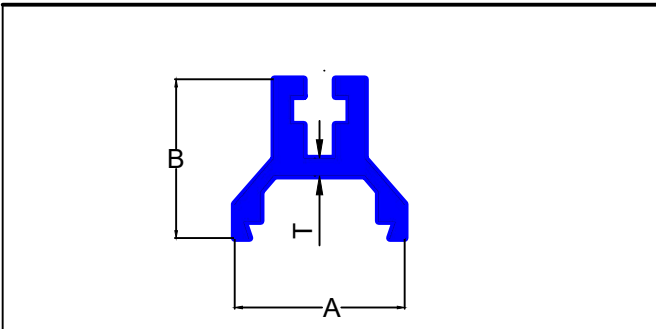

SEC.NO.	A	B	T	WT.Kg/mtr.
3905	15.00	14.00	1.50	0.167

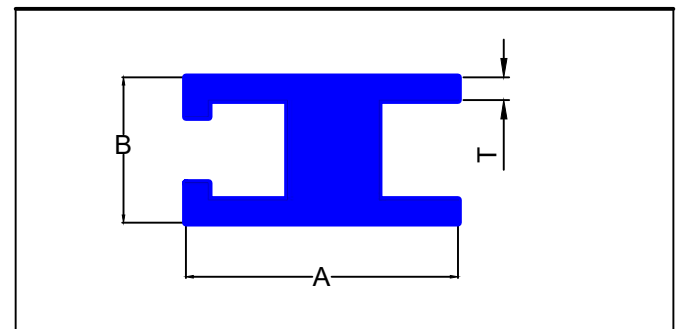

SEC.NO.	A	B	T	WT.Kg/mtr.
3909	24.00	12.80	2.00	0.465

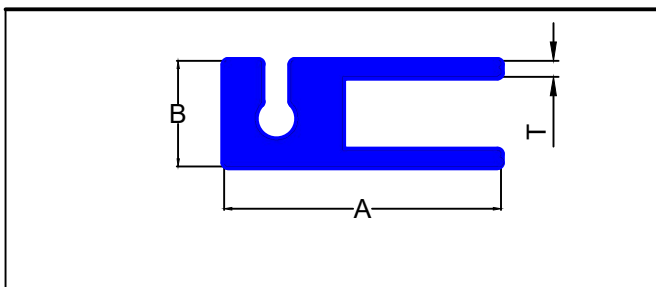

SEC.NO.	A	B	T	WT.Kg/mtr.
3911	24.40	9.30	1.40	0.312

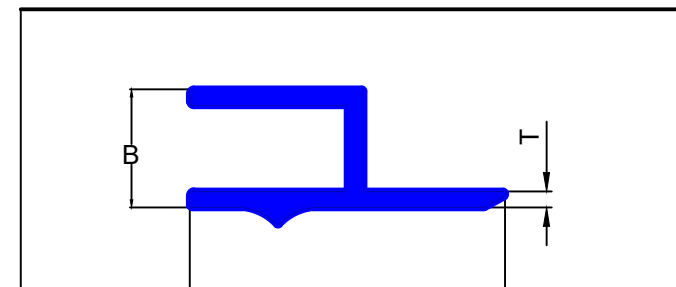

SEC.NO.	A	B	T	WT.Kg/mtr.
3912	34.75	13.00	1.75	0.309

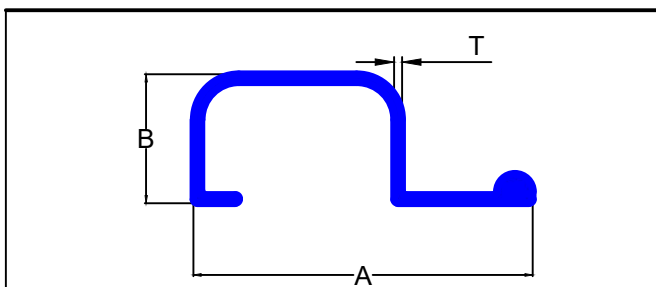

SEC.NO.	A	B	T	WT.Kg/mtr.
3915	37.40	14.20	0.90	0.174

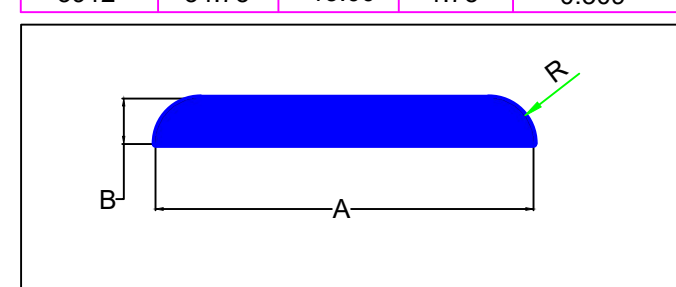

SEC.NO.	A	B	R	WT.Kg/mtr.
3918	25.00	3.00	3.00	0.192

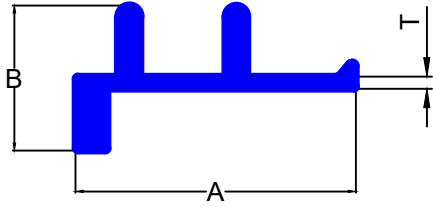

SEC.NO.	A	B	T	WT.Kg/mtr.
3920	37.10	19.20	1.60	0.407

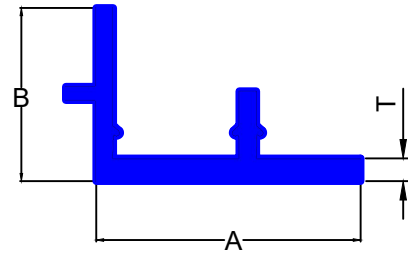

SEC.NO.	A	B	T	WT.Kg/mtr.
3921	35.00	22.90	3.00	0.484

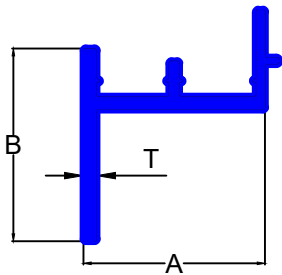

SEC.NO.	A	B	T	WT.Kg/mtr.
3923	40.00	42.50	2.90	0.790
3976	39.60	44.70	2.90	0.796

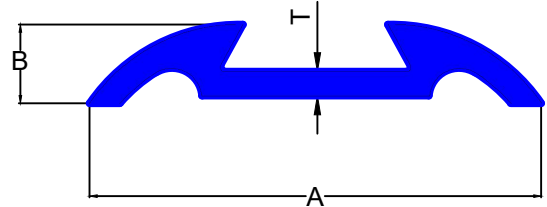

SEC.NO.	A	B	T	WT.Kg/mtr.
3924	29.90	5.20	1.60	0.174

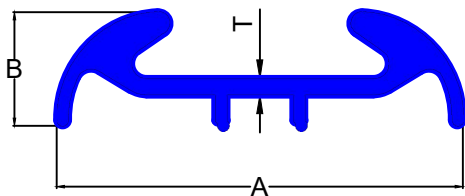

SEC.NO.	A	B	T	WT.Kg/mtr.
3927	53.70	15.00	2.10	0.623

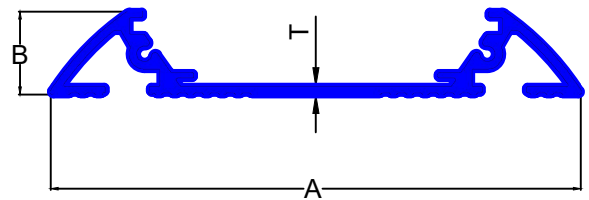

SEC.NO.	A	B	T	WT.Kg/mtr.
3928	100.25	15.70	1.50	0.699

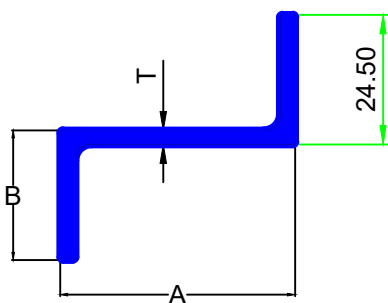

SEC.NO.	A	B	T	WT.Kg/mtr.
3930	44.45	24.50	2.70	0.674

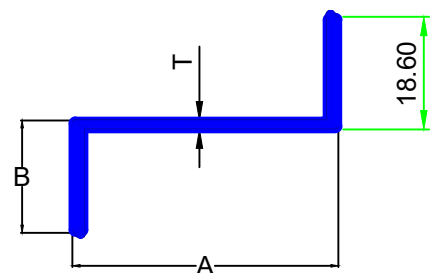

SEC.NO.	A	B	T	WT.Kg/mtr.
3931	44.00	18.60	1.50	0.362

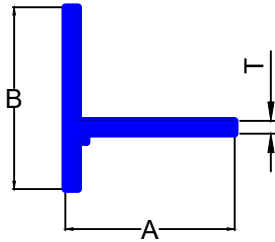

SEC.NO.	A	B	T	WT.Kg/mtr.
3933	40.00	43.00	3.00	0.657

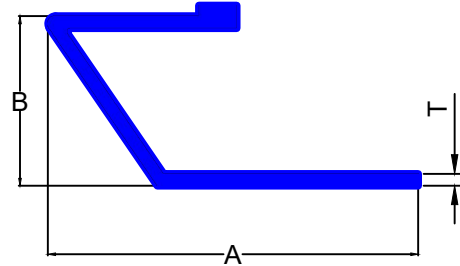

SEC.NO.	A	B	T	WT.Kg/mtr.
3936	49.00	22.50	1.60	0.379

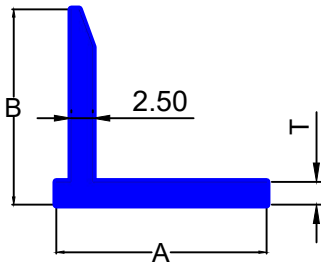

SEC.NO.	A	B	T	WT.Kg/mtr.
3938	28.00	25.60	2.70	0.351

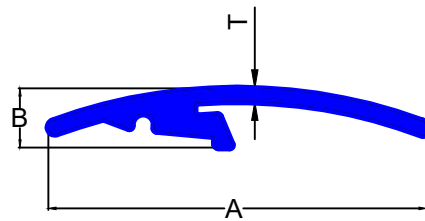

SEC.NO.	A	B	T	WT.Kg/mtr.
3943	50.00	7.80	1.70	0.339

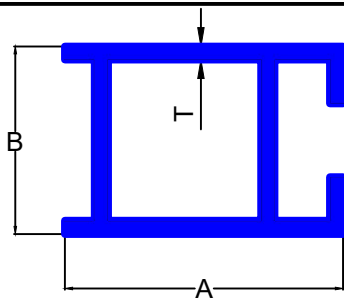

SEC.NO.	A	B	T	WT.Kg/mtr.
3944	46.00	31.00	2.18	0.939

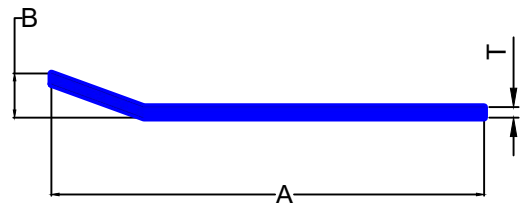

SEC.NO.	A	B	T	WT.Kg/mtr.
3946	57.25	5.85	1.40	0.216

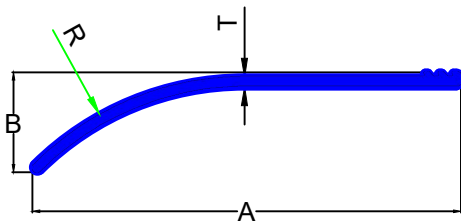

SEC.NO.	A	B	T	R	WT.Kg/mtr.
3948	141.90	33.00	3.20	198.10	1.307
3949	140.00	30.30	3.20	172.85	1.290

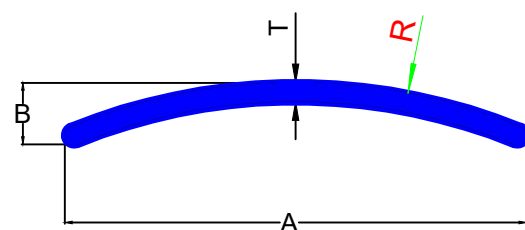

SEC.NO.	A	B	T	R	WT.Kg/mtr.
3950	76.50	10.15	3.10	99.10	0.649
3951	76.20	12.00	3.18	172.70	0.653

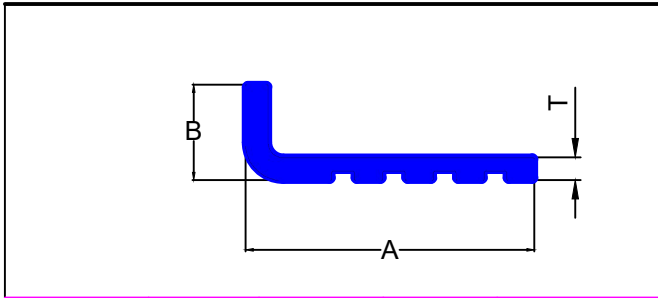

SEC.NO.	A	B	T	WT.Kg/mtr.
3954	38.20	12.60	3.00	0.332

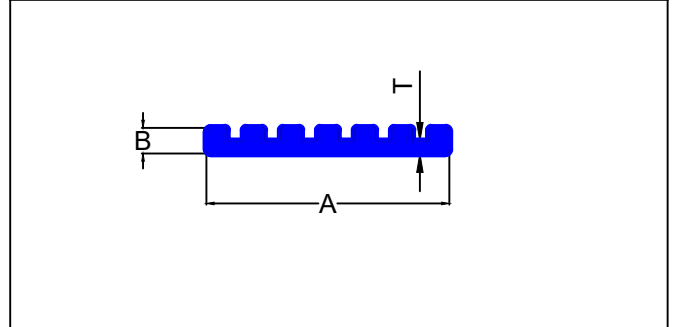

SEC.NO.	A	B	T	WT.Kg/mtr.
3955	32.10	3.40	1.60	0.229

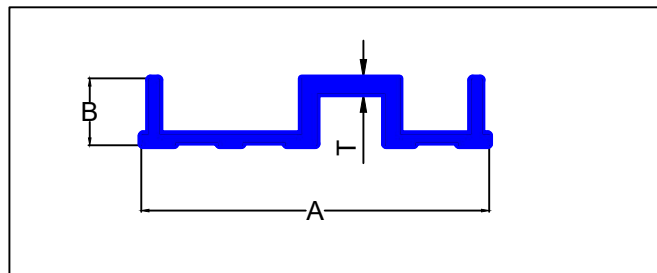

SEC.NO.	A	B	T	WT.Kg/mtr.
3959	92.00	17.70	2.00	1.001

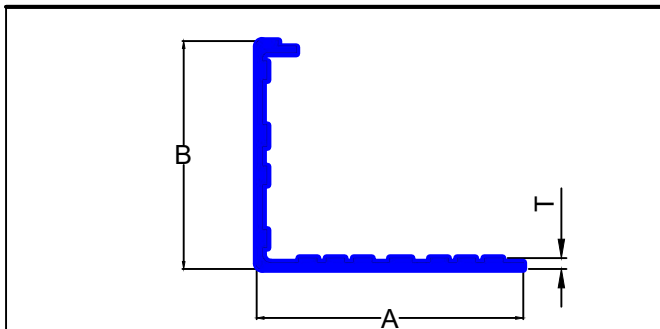

SEC.NO.	A	B	T	WT.Kg/mtr.
3961	147.00	125.70	6.00	3.575

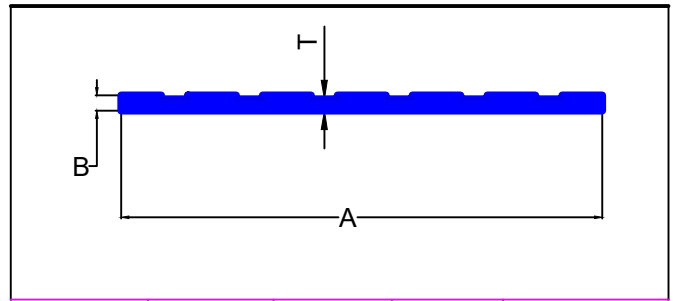

SEC.NO.	A	B	T	WT.Kg/mtr.
3963	90.00	2.90	2.15	0.646

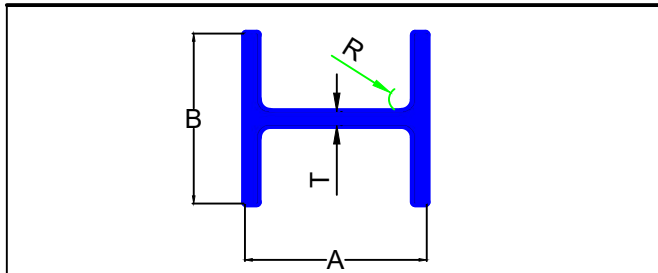

SEC.NO.	A	B	T	R	WT.Kg/mtr.
3969	47.60	44.45	3.40	3.25	1.215
3979	47.62	44.45	3.18	3.18	1.208

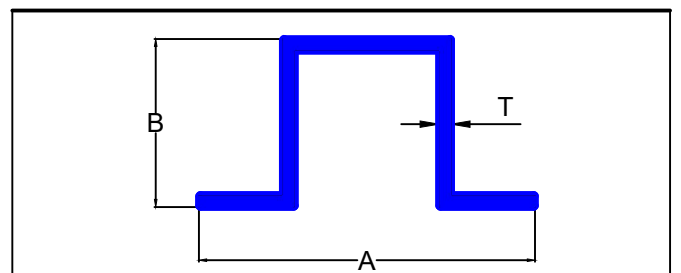

SEC.NO.	A	B	T	WT.Kg/mtr.
3972	88.90	44.45	3.18	1.471

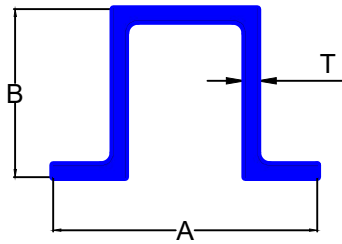

SEC.NO.	A	B	T	WT.Kg/mtr.
3974	69.85	44.45	3.18	1.333
3978	69.85	44.45	3.05	1.280

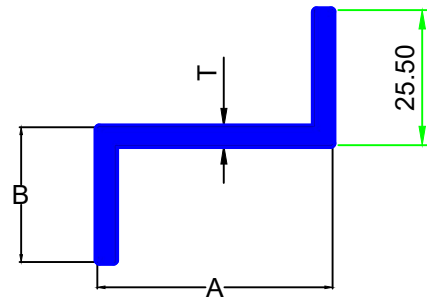

SEC.NO.	A	B	T	WT.Kg/mtr.
3975	44.45	25.50	3.20	0.767

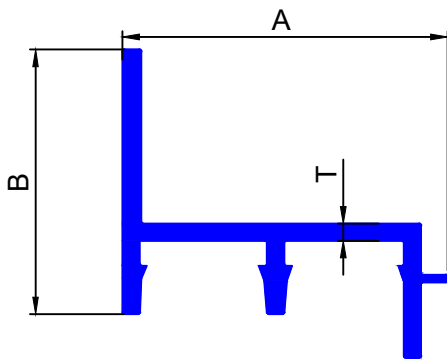

SEC.NO.	A	B	T	WT.Kg/mtr.
3980	43.00	35.00	2.30	0.644

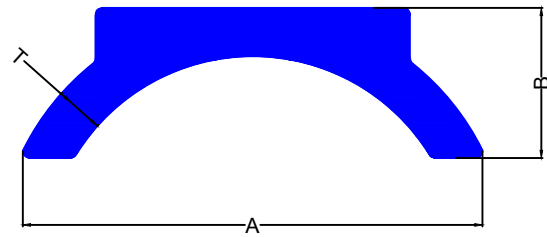

SEC.NO.	A	B	T	WT.Kg/mtr.
3981	19.00	6.20	2.00	0.137

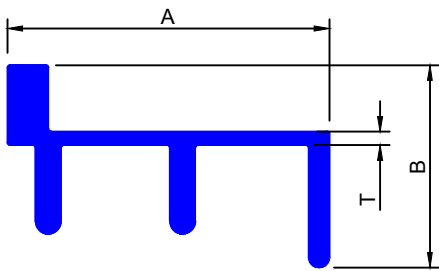

SEC.NO.	A	B	T	WT.Kg/mtr.
3982	35.50	22.30	1.50	0.458

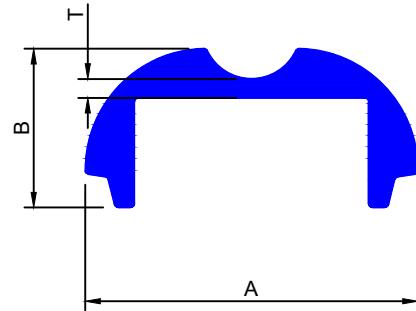

SEC.NO.	A	B	T	WT.Kg/mtr.
3983	44.00	21.00	2.50	0.810

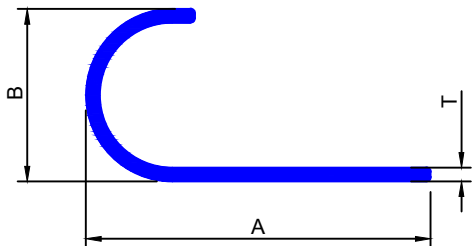

SEC.NO.	A	B	T	WT.Kg/mtr.
3984	38.00	19.00	1.50	0.236

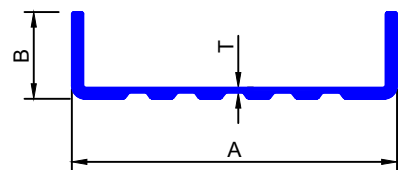

SEC.NO.	A	B	T	WT.Kg/mtr.
3985	86.00	23.00	1.40	0.880

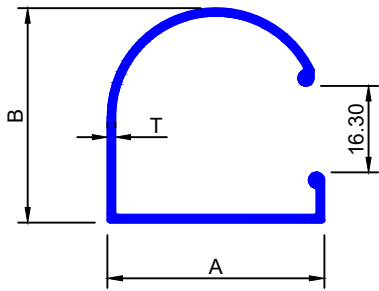

SEC.NO.	A	B	T	WT.Kg/mtr.
3986	41.00	40.50	1.50	0.516

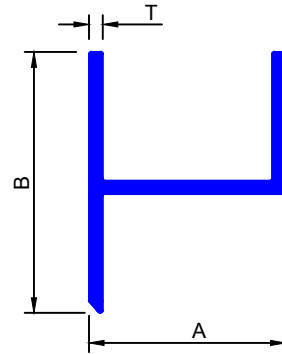

SEC.NO.	A	B	T	WT.Kg/mtr.
3987	26.00	34.50	1.80	0.365

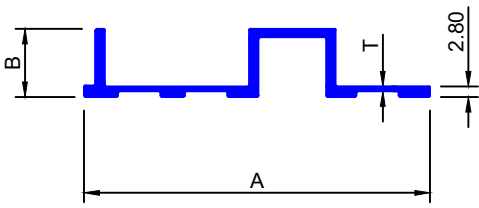

SEC.NO.	A	B	T	WT.Kg/mtr.
3988	91.50	18.00	1.30	0.836

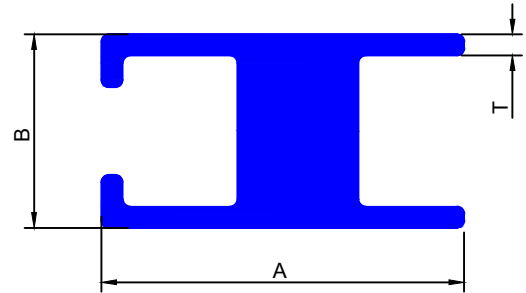

SEC.NO.	A	B	T	WT.Kg/mtr.
3989	24.00	12.80	1.40	0.412

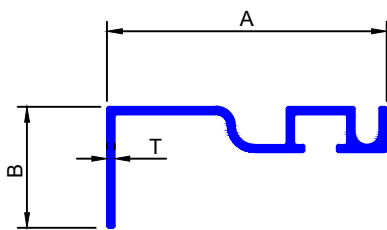

SEC.NO.	A	B	T	WT.Kg/mtr.
3990	74.00	32.00	2.00	0.795

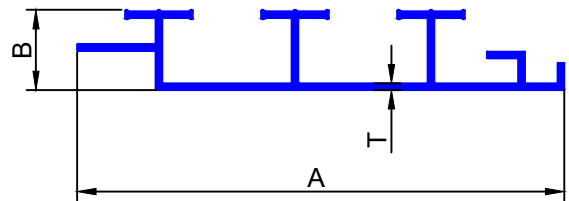

SEC.NO.	A	B	T	WT.Kg/mtr.
3991	179.00	29.50	2.50	2.420