

SEC.NO.	A	B	R	WT.Kg/mtr.
4702	14.90	18.40	9.20	0.641

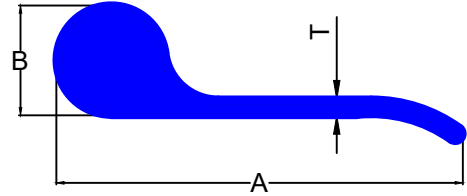

SEC.NO.	A	B	T	WT.Kg/mtr.
4703	53.75	14.50	2.10	0.724

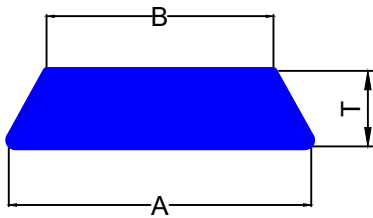

SEC.NO.	A	B	T	WT.Kg/mtr.
4704	40.00	30.00	10.00	0.958

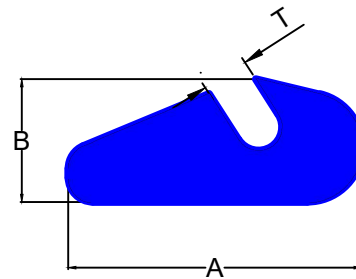

SEC.NO.	A	B	T	WT.Kg/mtr.
4705	48.50	20.30	7.80	1.757

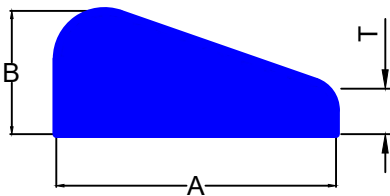

SEC.NO.	A	B	T	WT.Kg/mtr.
4706	46.25	20.40	7.65	1.861

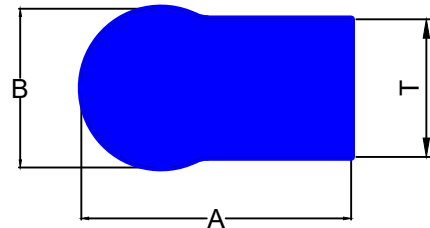

SEC.NO.	A	B	T	WT.Kg/mtr.
4707	51.00	30.00	26.00	3.536

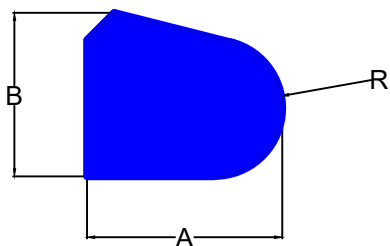

SEC.NO.	A	B	R	WT.Kg/mtr.
4710	43.50	36.50	15.30	3.573

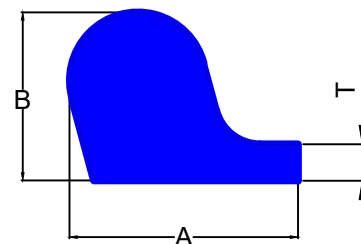

SEC.NO.	A	B	T	WT.Kg/mtr.
4712	50.40	37.00	8.00	3.150

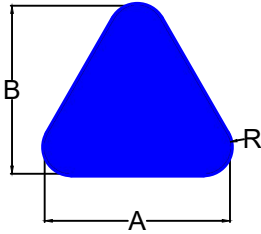

SEC.NO.	A	B	R	WT.Kg/mtr.
4713	49.00	44.40	7.00	3.840

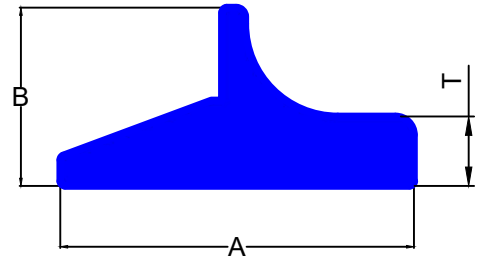

SEC.NO.	A	B	T	WT.Kg/mtr.
4714	78.00	39.25	15.30	3.562

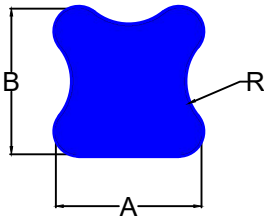

SEC.NO.	A	B	R	WT.Kg/mtr.
4715	77.00	77.00	30.00	13.344

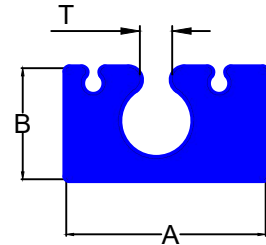

SEC.NO.	A	B	T	WT.Kg/mtr.
4718	19.70	11.30	3.30	0.447
4719	21.70	11.30	3.30	0.504

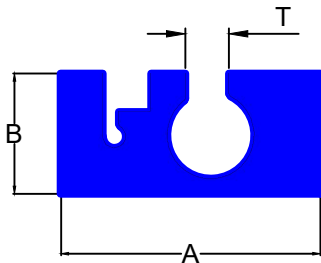

SEC.NO.	A	B	T	WT.Kg/mtr.
4721	22.95	10.60	3.85	0.460

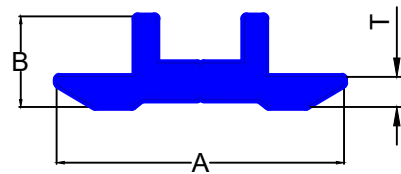

SEC.NO.	A	B	T	WT.Kg/mtr.
4722	38.00	12.00	4.00	0.501

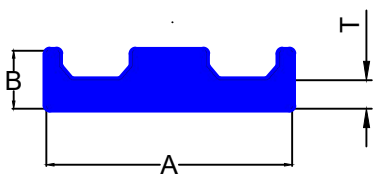

SEC.NO.	A	B	T	WT.Kg/mtr.
4723	25.00	5.90	2.90	0.286

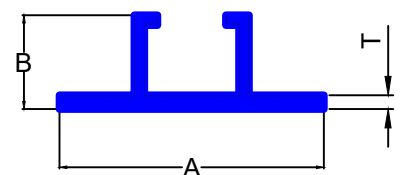

SEC.NO.	A	B	T	WT.Kg/mtr.
4724	35.00	12.40	1.80	0.256

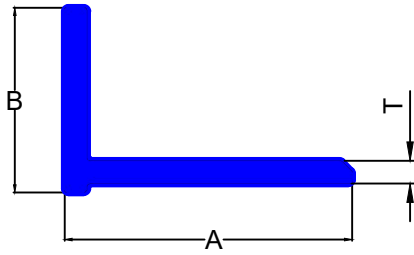

SEC.NO.	A	B	T	WT.Kg/mtr.
4725	38.00	24.40	3.00	9.192

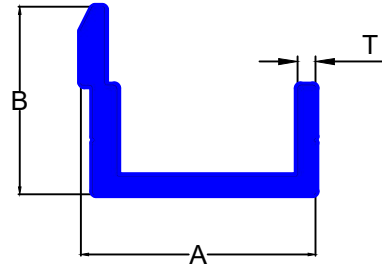

SEC.NO.	A	B	T	WT.Kg/mtr.
4726	36.80	31.00	3.00	0.709

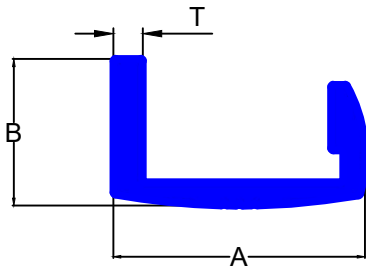

SEC.NO.	A	B	T	WT.Kg/mtr.
4727	28.20	16.80	3.90	0.434
4728	33.30	19.40	3.90	0.519

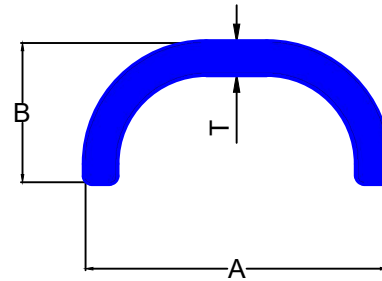

SEC.NO.	A	B	T	WT.Kg/mtr.
4729	50.00	23.00	5.00	0.955

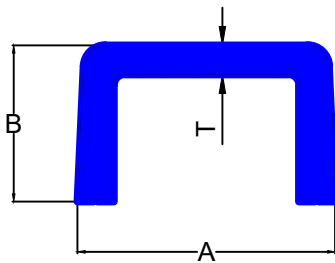

SEC.NO.	A	B	T	WT.Kg/mtr.
4730	71.00	43.00	8.00	3.173

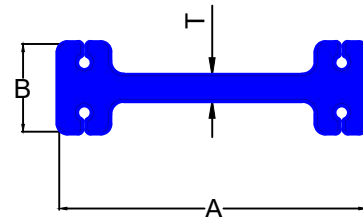

SEC.NO.	A	B	T	WT.Kg/mtr.
4731	40.60	11.60	3.00	0.572

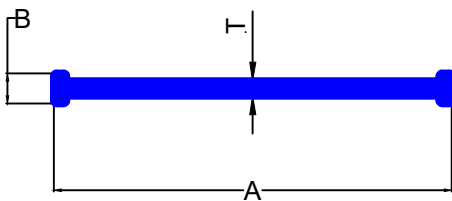

SEC.NO.	A	B	T	WT.Kg/mtr.
4732	40.50	3.05	1.50	0.174

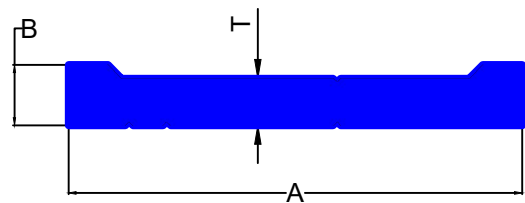

SEC.NO.	A	B	T	WT.Kg/mtr.
4734	65.00	8.00	6.50	1.210

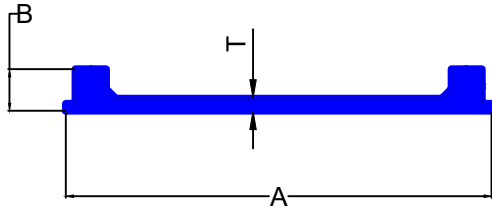

SEC.NO.	A	B	T	WT.Kg/mtr.
4735	44.00	8.00	2.50	0.484
4736	88.00	8.60	2.50	0.801

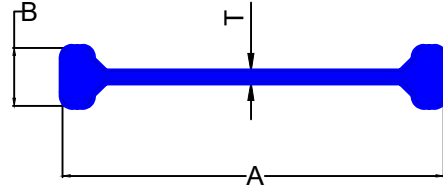

SEC.NO.	A	B	T	WT.Kg/mtr.
4737	84.00	12.80	2.00	0.856

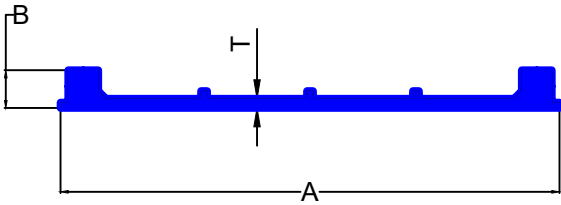

SEC.NO.	A	B	T	WT.Kg/mtr.
4738	132.00	10.00	2.50	1.242

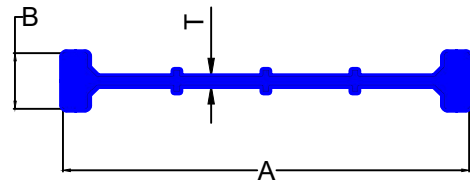

SEC.NO.	A	B	T	WT.Kg/mtr.
4739	128.00	17.50	2.50	1.611

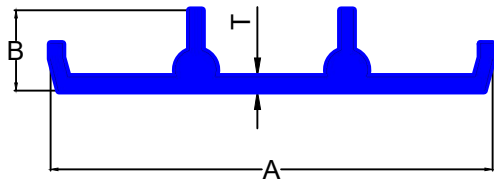

SEC.NO.	A	B	T	WT.Kg/mtr.
4740	146.20	26.50	4.50	2.796

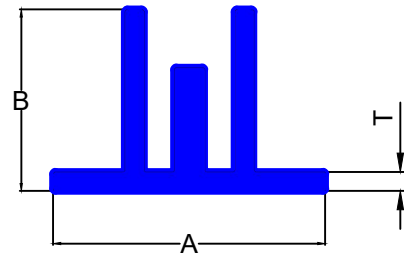

SEC.NO.	A	B	T	WT.Kg/mtr.
4741	36.00	24.00	2.50	0.682

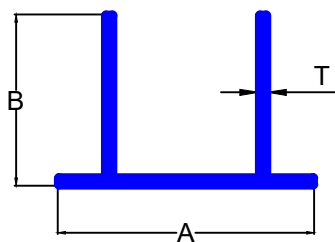

SEC.NO.	A	B	T	WT.Kg/mtr.
4742	60.00	40.00	2.00	0.734
4743	80.00	45.00	2.00	0.896

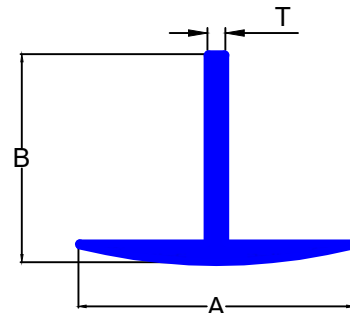

SEC.NO.	A	B	T	WT.Kg/mtr.
4744	73.00	55.00	4.80	1.343

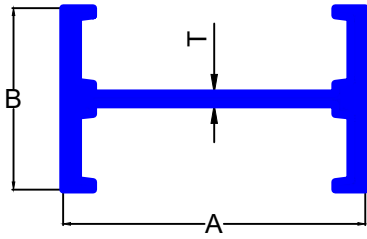

SEC.NO.	A	B	T	WT.Kg/mtr.
4745	80.00	48.00	3.00	1.836

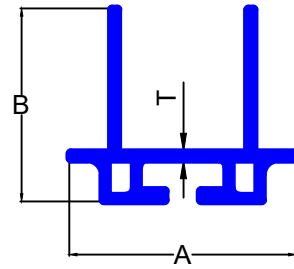

SEC.NO.	A	B	T	WT.Kg/mtr.
4746	60.00	51.00	2.00	1.108

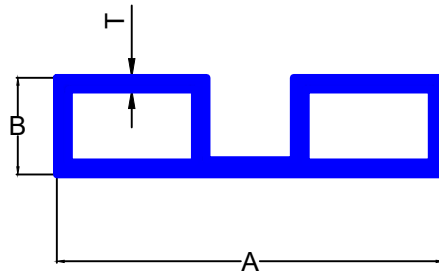

SEC.NO.	A	B	T	WT.Kg/mtr.
4747	80.00	20.00	2.50	1.387

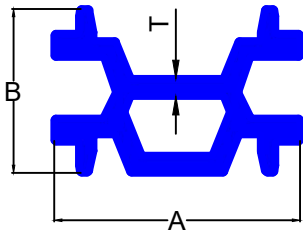

SEC.NO.	A	B	T	WT.Kg/mtr.
4748	50.00	33.30	3.50	1.499
4749	100.00	44.50	4.50	3.300
4750	100.00	46.20	4.50	3.430

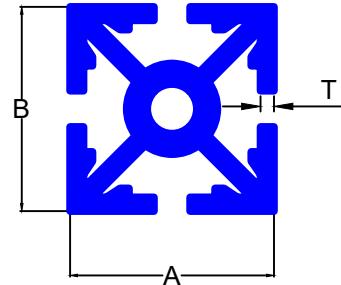

SEC.NO.	A	B	T	WT.Kg/mtr.
4752	45.00	45.00	3.00	2.390

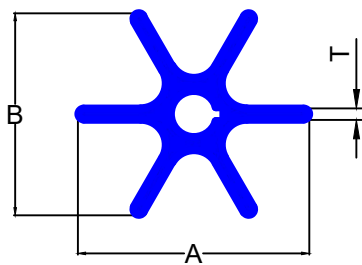

SEC.NO.	A	B	T	WT.Kg/mtr.
4753	102.00	89.00	5.00	4.346

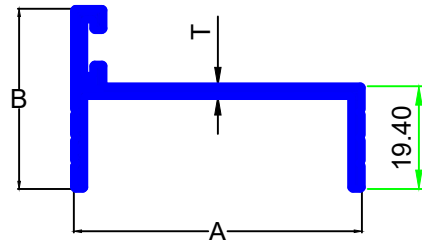

SEC.NO.	A	B	T	WT.Kg/mtr.
4754	54.40	34.00	1.90	0.603

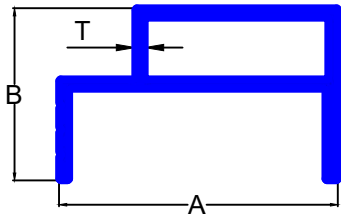

SEC.NO.	A	B	T	WT.Kg/mtr.
4755	54.90	33.90	1.90	0.824

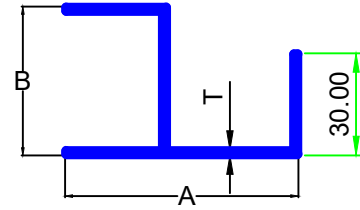

SEC.NO.	A	B	T	WT.Kg/mtr.
4756	69.30	43.70	1.60	0.723

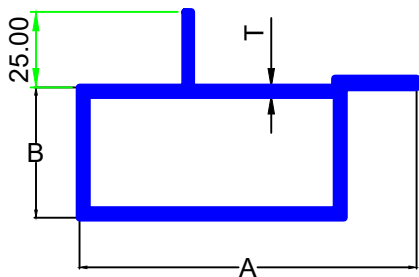

SEC.NO.	A	B	T	WT.Kg/mtr.
4759	111.50	43.00	2.50	2.047

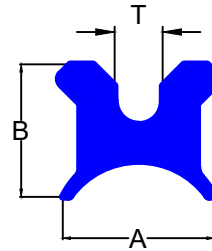

SEC.NO.	A	B	T	WT.Kg/mtr.
4761	20.00	17.50	6.35	0.496

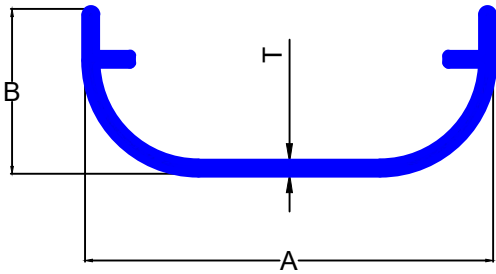

SEC.NO.	A	B	T	WT.Kg/mtr.
4762	54.00	21.80	1.50	0.370

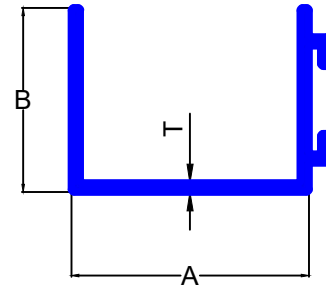

SEC.NO.	A	B	T	WT.Kg/mtr.
4763	49.10	38.00	1.80	0.672

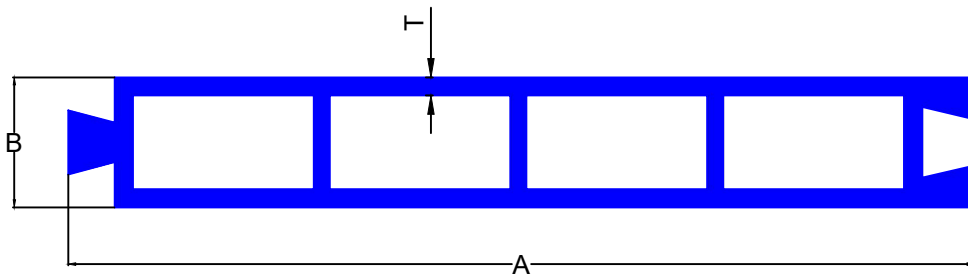

SEC.NO.	A	B	T	WT.Kg/mtr.
4765	149.90	21.50	3.00	3.202

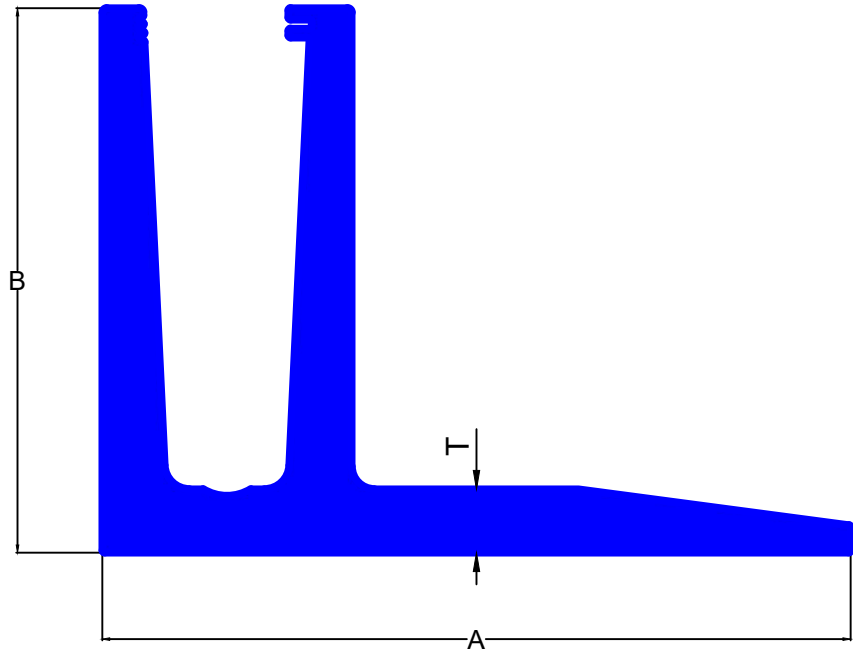

SEC.NO.	A	B	T	WT.Kg/mtr.
4766	165.00	120.00	14.00	12.233

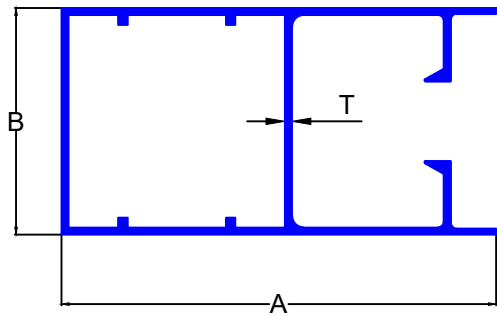

SEC.NO.	A	B	T	WT.Kg/mtr.
4768	115.00	60.00	1.90	2.056

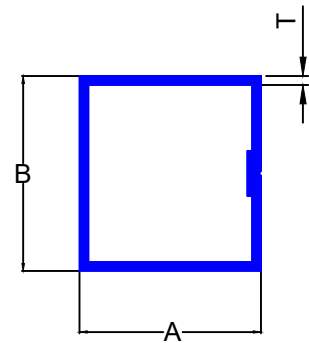

SEC.NO.	A	B	T	WT.Kg/mtr.
4769	40.00	43.00	2.00	0.879

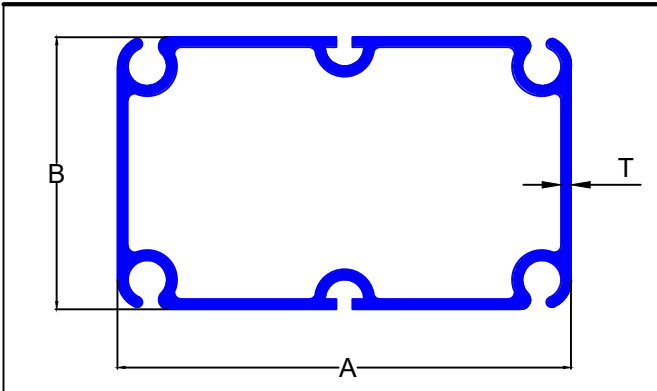

SEC.NO.	A	B	T	WT.Kg/mtr.
4770	200.00	120.00	4.50	9.470

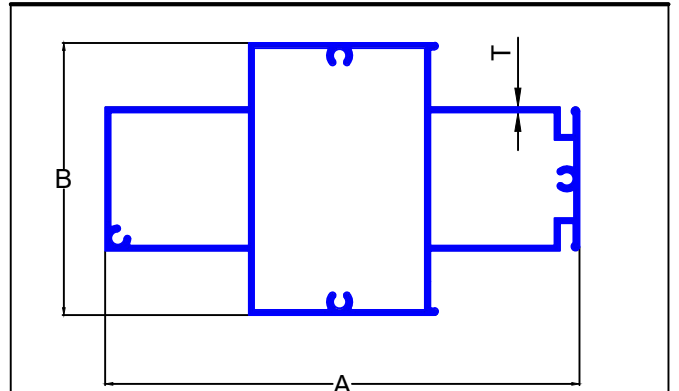

SEC.NO.	A	B	T	WT.Kg/mtr.
4771	125.50	72.00	1.40	1.977

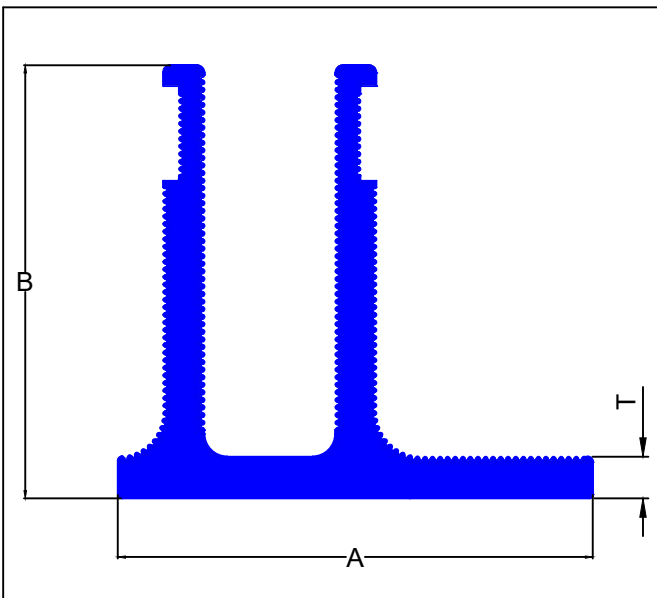

SEC.NO.	A	B	T	WT.Kg/mtr.
4772	125.70	114.50	11.00	8.871

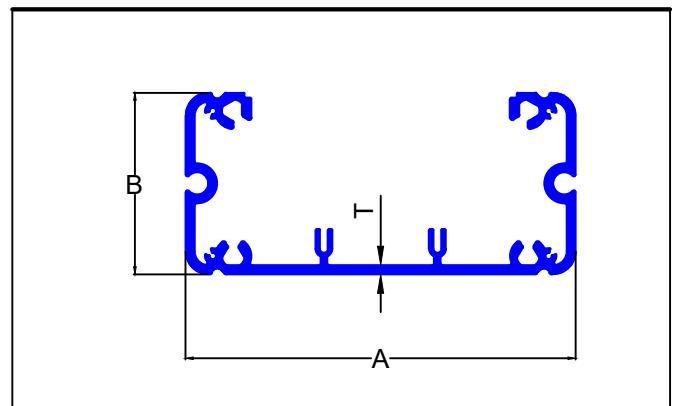

SEC.NO.	A	B	T	WT.Kg/mtr.
4773	172.00	80.00	4.00	5.544

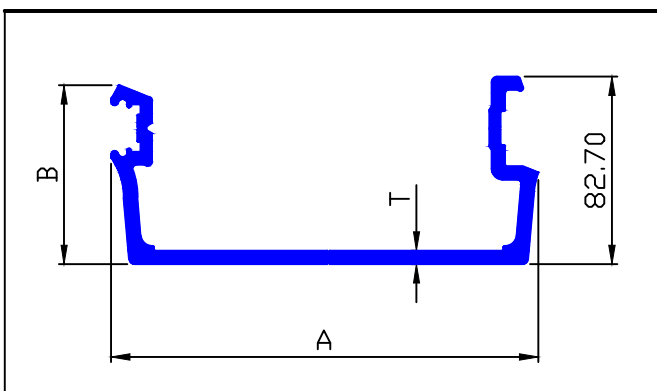

SEC.NO.	A	B	T	WT.Kg/mtr.
4774	188.43	79.00	6.00	5.900

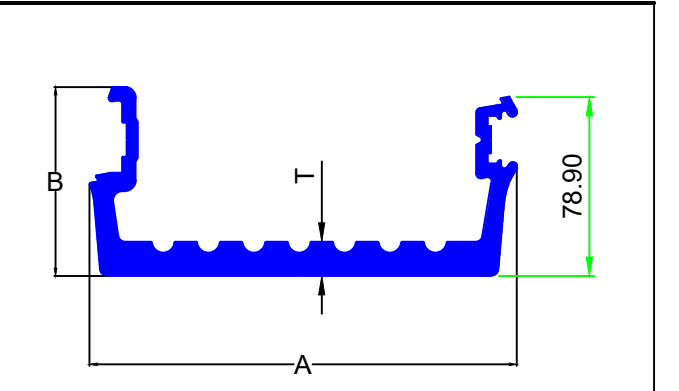

SEC.NO.	A	B	T	WT.Kg/mtr.
4775	188.50	83.20	15.00	9.412

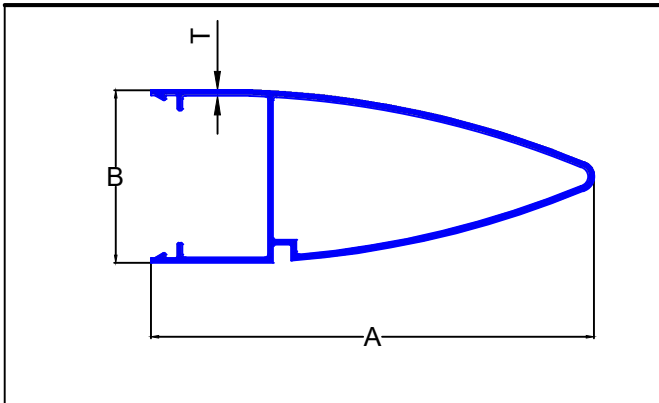

SEC.NO.	A	B	T	WT.Kg/mtr.
4776	146.46	57.00	1.80	1.799

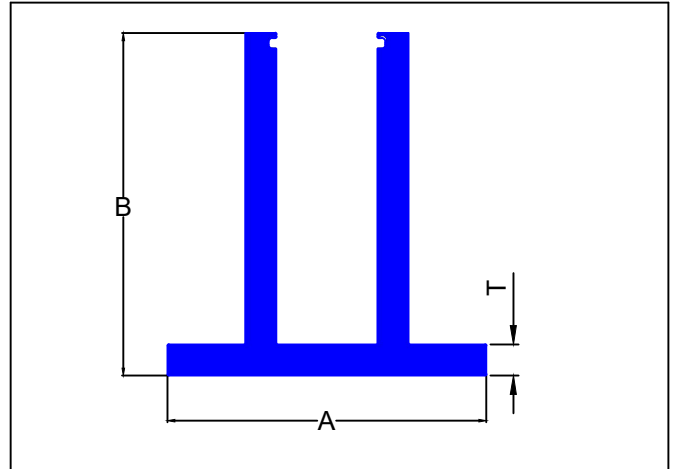

SEC.NO.	A	B	T	WT.Kg/mtr.
4777	123.00	132.00	12.00	11.700

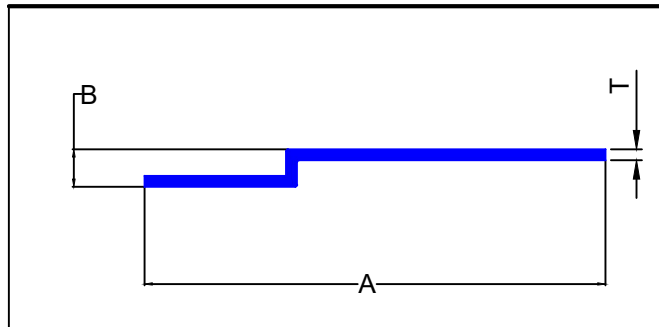

SEC.NO.	A	B	T	WT.Kg/mtr.
4778	254.00	20.50	6.00	4.349

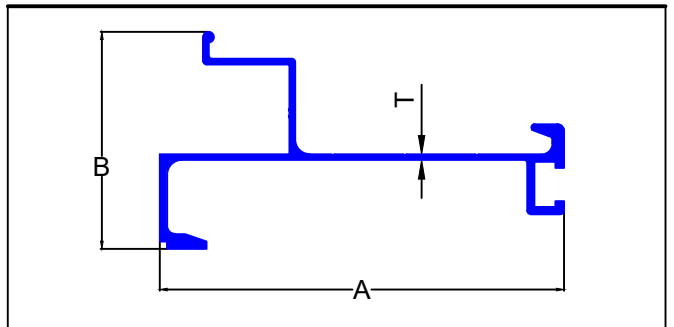

SEC.NO.	A	B	T	WT.Kg/mtr.
4779	178.50	95.60	2.50	3.165

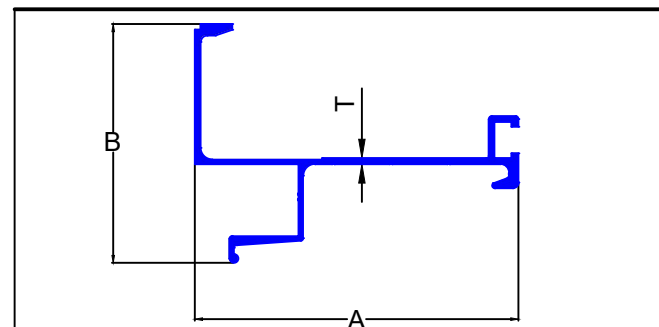

SEC.NO.	A	B	T	WT.Kg/mtr.
4780	178.30	131.60	3.30	3.804

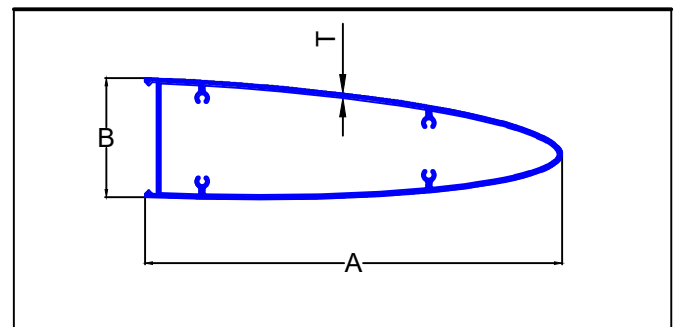

SEC.NO.	A	B	T	WT.Kg/mtr.
4781	230.00	65.49	2.50	3.927

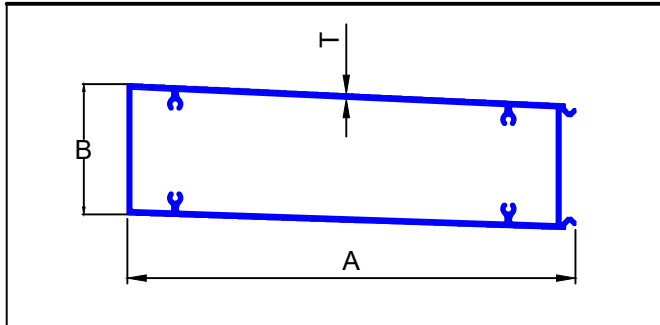

SEC.NO.	A	B	T	WT.Kg/mtr.
4782	235.26	68.49	2.50	4.320

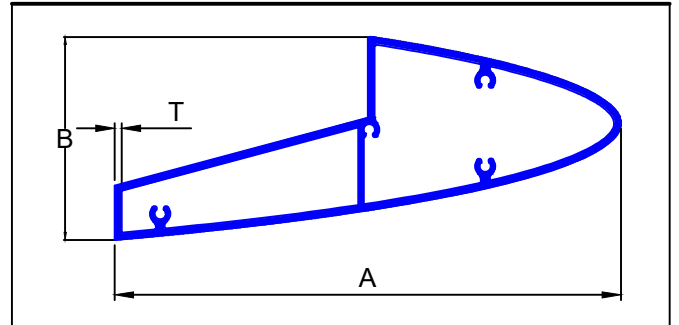

SEC.NO.	A	B	T	WT.Kg/mtr.
4783	186.00	74.75	2.50	3.373

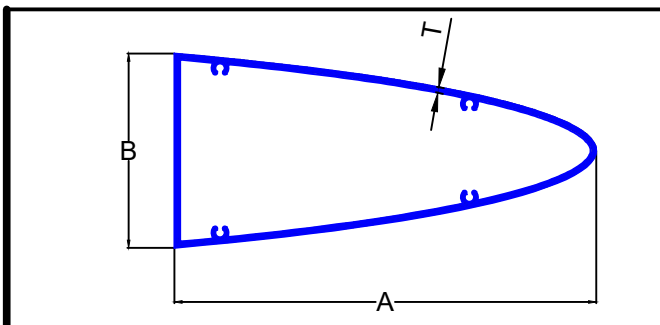

SEC.NO.	A	B	T	WT.Kg/mtr.
4784	186.00	85.60	2.50	3.351

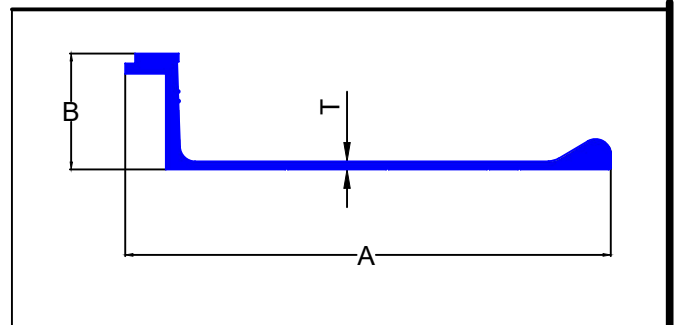

SEC.NO.	A	B	T	WT.Kg/mtr.
4785	152.95	36.53	2.54	1.750

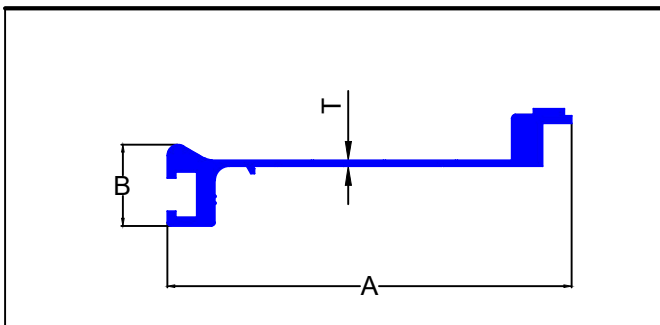

SEC.NO.	A	B	T	WT.Kg/mtr.
4786	178.30	35.79	2.54	3.190

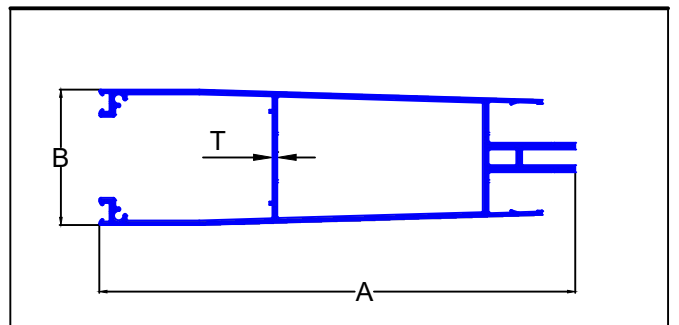

SEC.NO.	A	B	T	WT.Kg/mtr.
4787	209.80	59.60	2.00	3.571

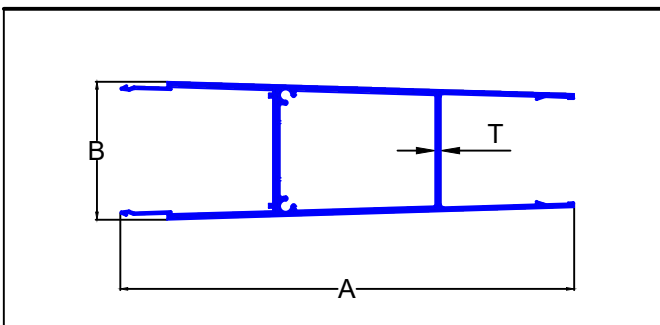

SEC.NO.	A	B	T	WT.Kg/mtr.
4788	166.82	50.70	2.00	2.178

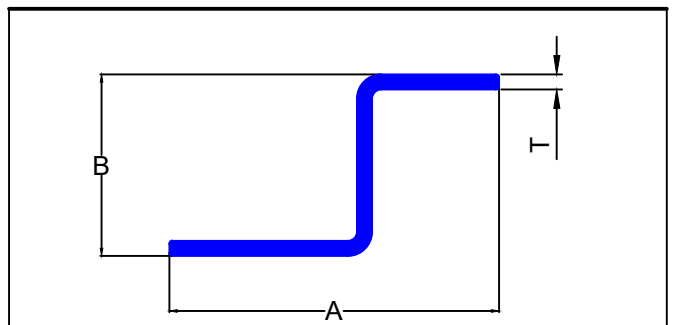

SEC.NO.	A	B	T	WT.Kg/mtr.
4789	109.00	60.00	5.00	2.147

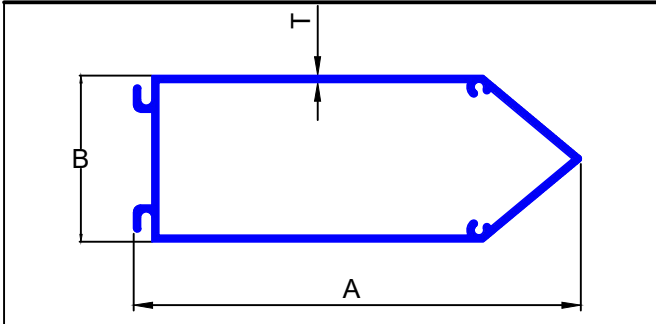

SEC.NO.	A	B	T	WT.Kg/mtr.
4790	134.44	50.00	2.00	1.917

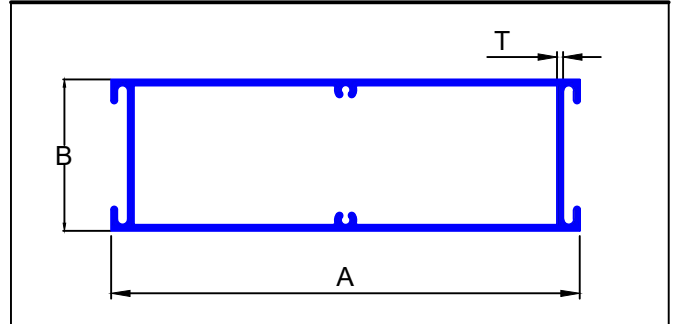

SEC.NO.	A	B	T	WT.Kg/mtr.
4791	155.00	50.00	2.00	2.398

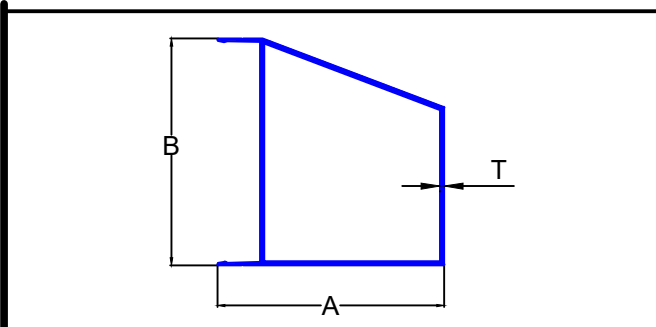

SEC.NO.	A	B	T	WT.Kg/mtr.
4792	100.00	100.00	1.80	1.743

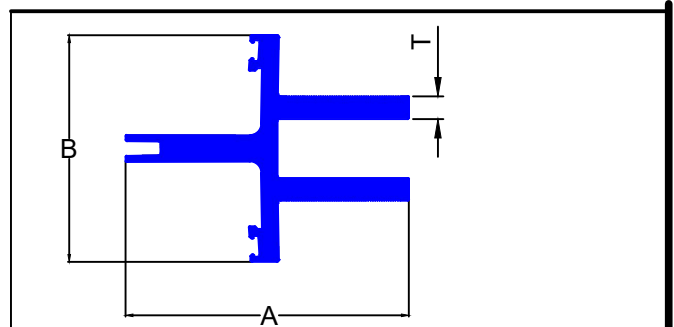

SEC.NO.	A	B	T	WT.Kg/mtr.
4793	124.99	99.99	10.00	6.944

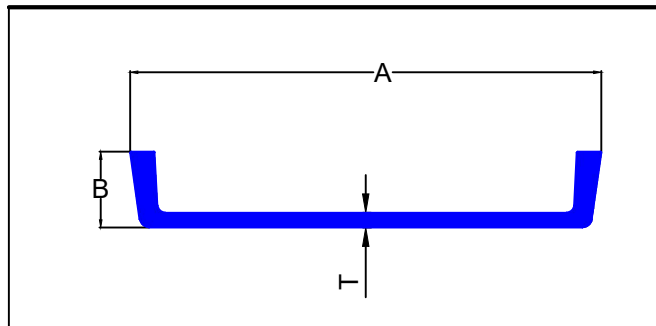

SEC.NO.	A	B	T	WT.Kg/mtr.
4794	249.20	40.00	7.75	7.008

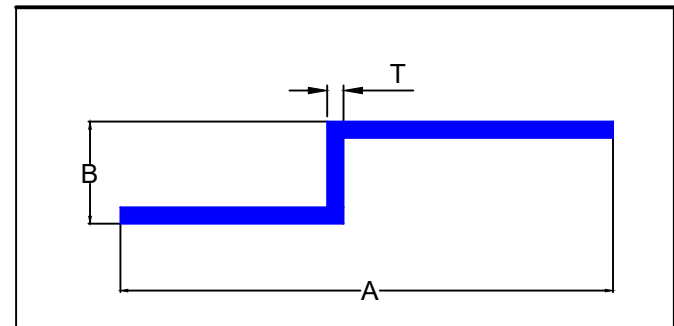

SEC.NO.	A	B	T	WT.Kg/mtr.
4795	181.00	37.50	6.00	3.442

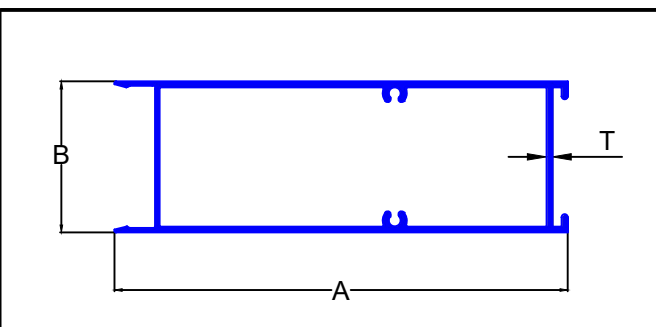

SEC.NO.	A	B	T	WT.Kg/mtr.
4796	149.85	50.00	2.00	2.172

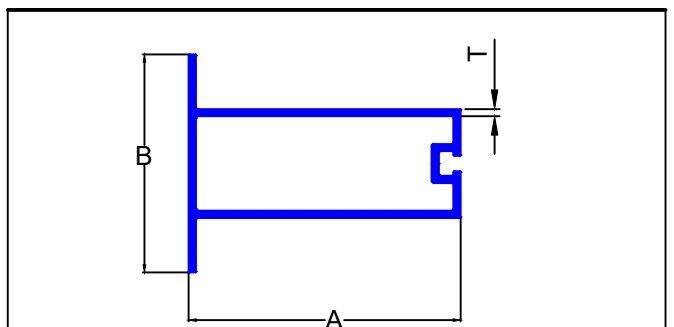

SEC.NO.	A	B	T	WT.Kg/mtr.
4797	150.00	120.00	4.00	5.326

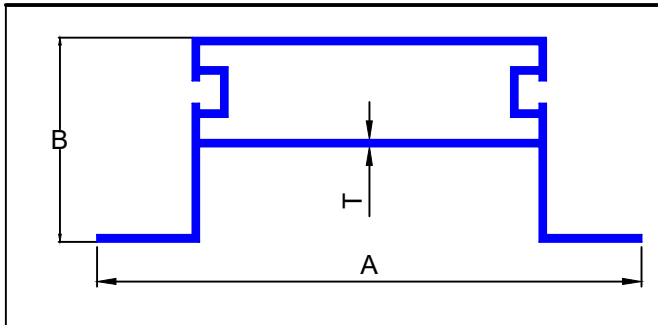

SEC.NO.	A	B	T	WT.Kg/mtr.
4798	200.00	75.00	2.50	3.522

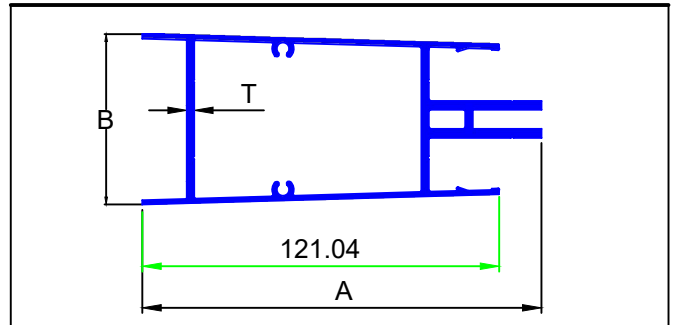

SEC.NO.	A	B	T	WT.Kg/mtr.
4799	135.40	57.81	2.50	2.658

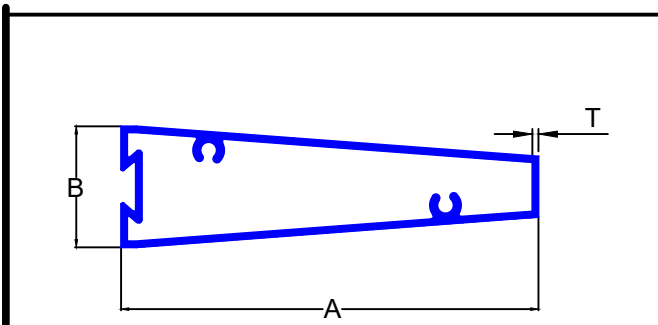

SEC.NO.	A	B	T	WT.Kg/mtr.
4800	138.00	40.00	2.00	2.140

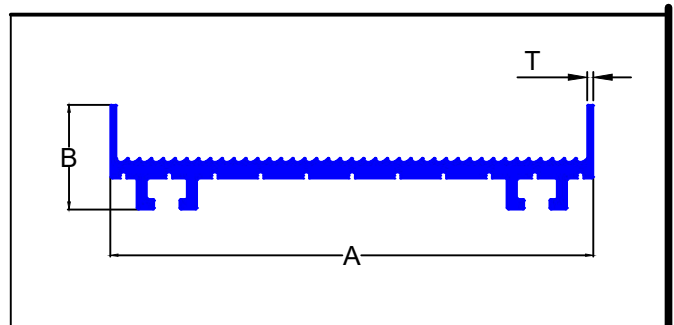

SEC.NO.	A	B	T	WT.Kg/mtr.
4801	163.75	35.50	2.00	3.255

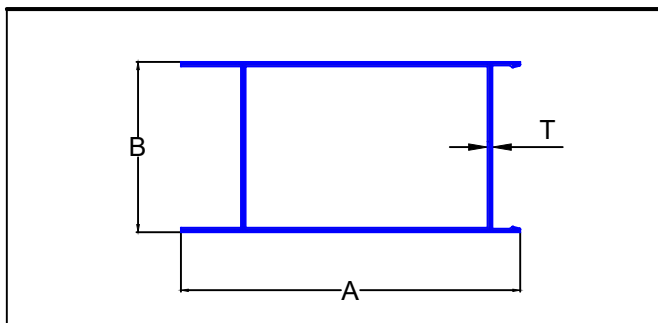

SEC.NO.	A	B	T	WT.Kg/mtr.
4802	149.67	75.00	2.00	2.360

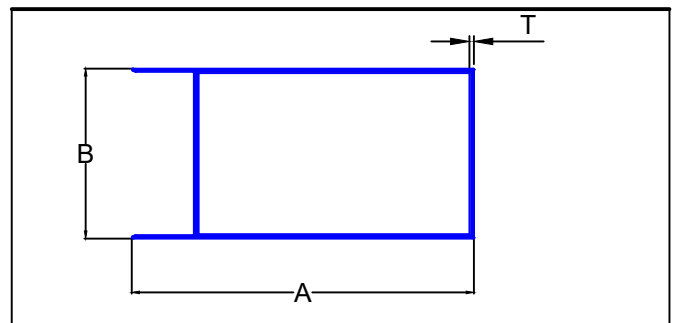

SEC.NO.	A	B	T	WT.Kg/mtr.
4803	150.82	74.97	2.00	3.442

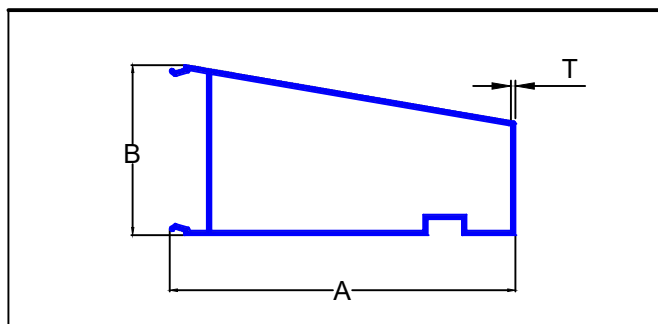

SEC.NO.	A	B	T	WT.Kg/mtr.
4804	152.40	75.00	2.00	2.376

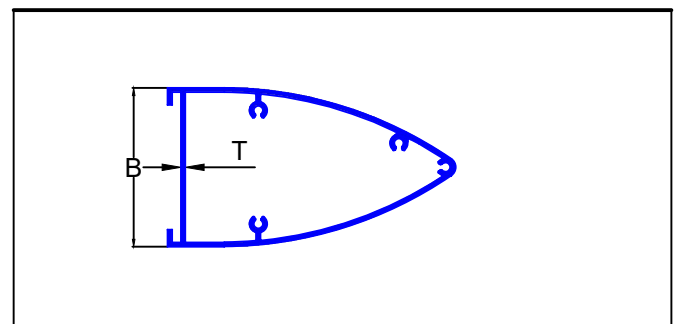

SEC.NO.	A	B	T	WT.Kg/mtr.
4805	127.00	70.00	1.80	2.003

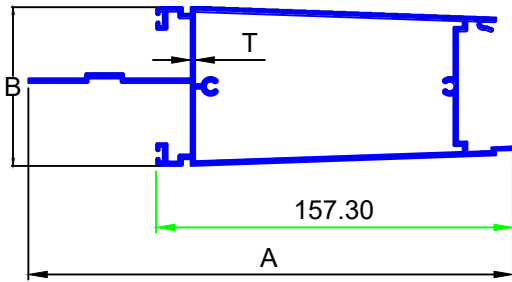

SEC.NO.	A	B	T	WT.Kg/mtr.
4806	213.58	70.00	2.00	3.133

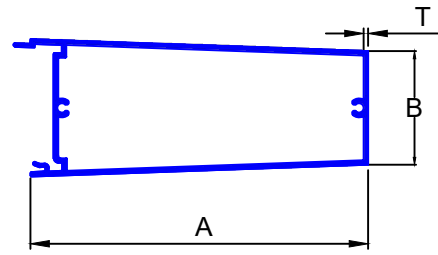

SEC.NO.	A	B	T	WT.Kg/mtr.
4807	148.93	50.11	2.00	2.379

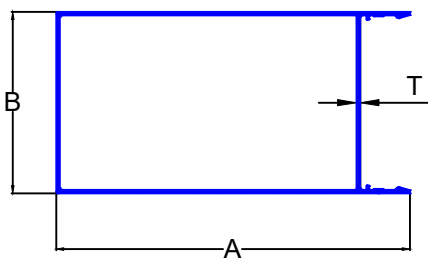

SEC.NO.	A	B	T	WT.Kg/mtr.
4808	195.00	100.00	2.00	3.207

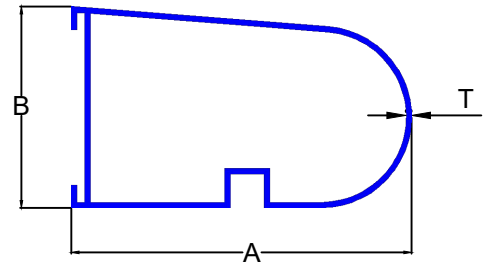

SEC.NO.	A	B	T	WT.Kg/mtr.
4809	150.00	88.87	2.50	3.179

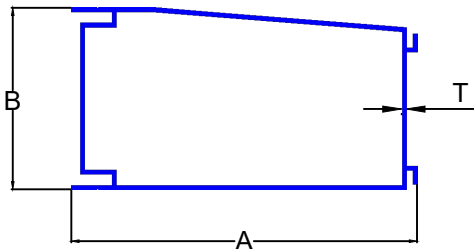

SEC.NO.	A	B	T	WT.Kg/mtr.
4810	190.50	100.00	2.50	4.119

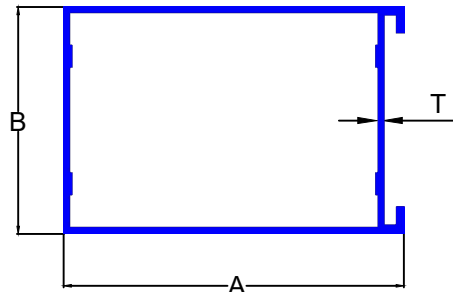

SEC.NO.	A	B	T	WT.Kg/mtr.
4811	150.00	100.00	3.00	4.282

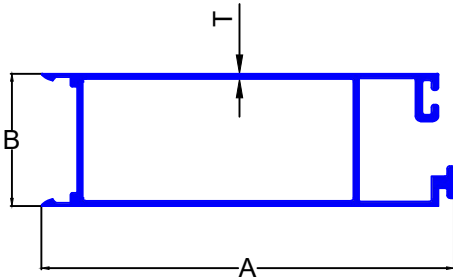

SEC.NO.	A	B	T	WT.Kg/mtr.
4812	155.92	50.00	2.00	2.481

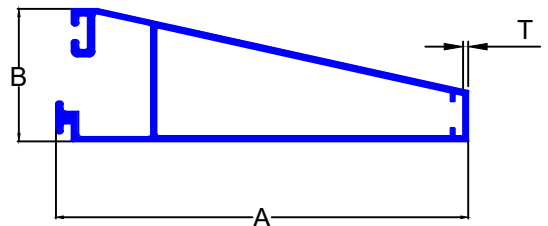

SEC.NO.	A	B	T	WT.Kg/mtr.
4813	149.90	50.00	2.00	2.321

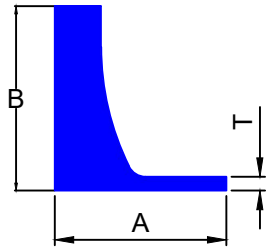

SEC.NO.	A	B	T	WT.Kg/mtr.
4814	118.10	127.00	9.53	14.935

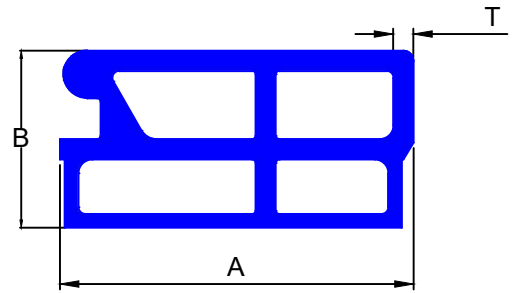

SEC.NO.	A	B	T	WT.Kg/mtr.
4815	104.00	52.00	6.00	6.300

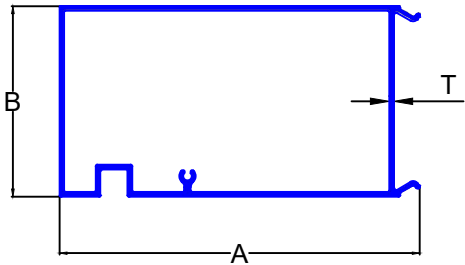

SEC.NO.	A	B	T	WT.Kg/mtr.
4816	132.39	70.00	1.70	1.994

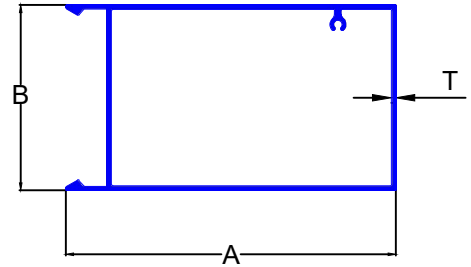

SEC.NO.	A	B	T	WT.Kg/mtr.
4817	124.65	70.00	1.70	1.847

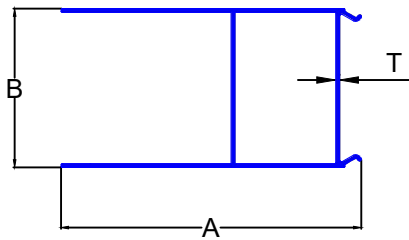

SEC.NO.	A	B	T	WT.Kg/mtr.
4818	132.39	70.00	1.70	1.837

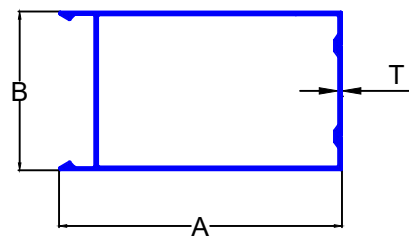

SEC.NO.	A	B	T	WT.Kg/mtr.
4819	124.65	70.00	1.70	1.854

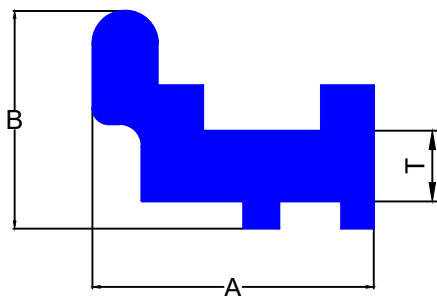

SEC.NO.	A	B	T	WT.Kg/mtr.
4820	155.00	120.00	39.00	24.483

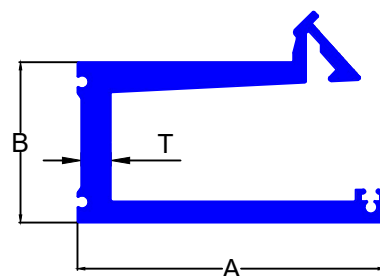

SEC.NO.	A	B	T	WT.Kg/mtr.
4821	125.50	65.20	12.00	7.542

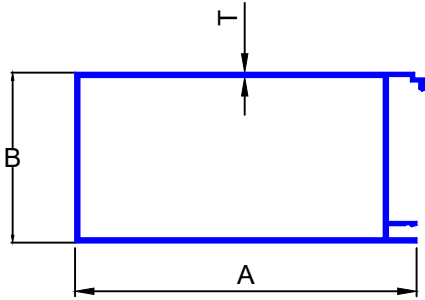

SEC.NO.	A	B	T	WT.Kg/mtr.
4822	150.50	75.00	2.00	2.481

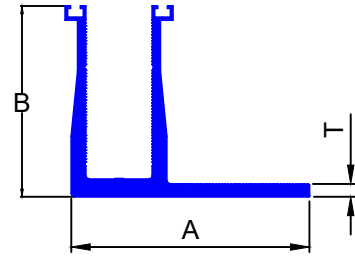

SEC.NO.	A	B	T	WT.Kg/mtr.
4823	150.00	120.00	8.00	7.459

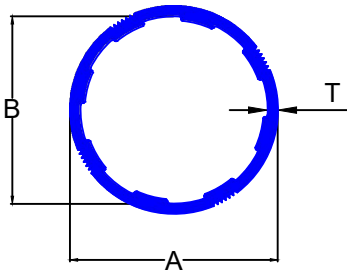

SEC.NO.	A	B	T	WT.Kg/mtr.
4824	13.75	12.40	1.35	0.355

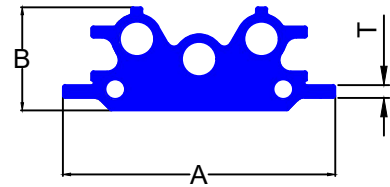

SEC.NO.	A	B	T	WT.Kg/mtr.
4825	120.00	45.50	5.70	7.033

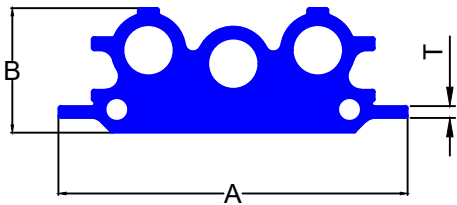

SEC.NO.	A	B	T	WT.Kg/mtr.
4826	132.00	47.00	4.50	8.233

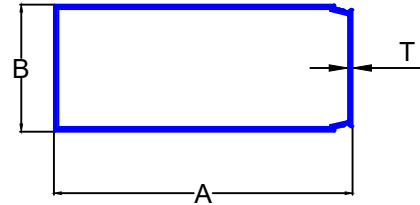

SEC.NO.	A	B	T	WT.Kg/mtr.
4827	131.80	56.00	2.00	1.971

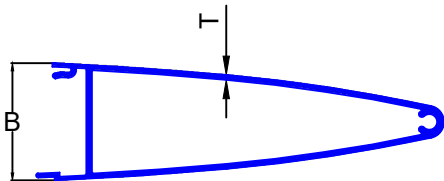

SEC.NO.	A	B	T	WT.Kg/mtr.
4828	153.98	44.30	1.80	1.792

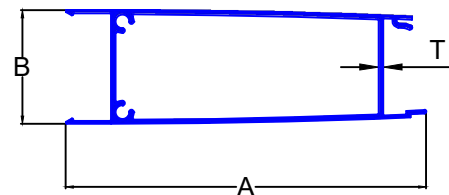

SEC.NO.	A	B	T	WT.Kg/mtr.
4829	158.98	50.00	1.80	2.073